

Who we are, what we do : 7

About this book..... 8

Instruments Repaired by IES..... 9

Repaired Instrument Warranty..... 10

Quotation Policy 11

General Technical Articles 12

Calibration Weights , Frequently Asked Questions 12

Drifty Analytical Balances 15

Linearity 16

Appraising the Condition of Lab Balances 17

Cornerload..... 18

"Monobloc" Cornerload Adjustment..... 19

Cornerload Adjustment Chart..... 20

Weight Tolerances..... 21

Linearity Adjustment Chart..... 23

The Force Restoration Principle..... 24

Packaging Lab Balances for Shipment 25

Static Electricity and Drifty Lab Balances..... 26

Moisture Balances - Practical Considerations 27

Standard Field Service..... 28

Description of Service 29

Service Record 30

Generalized Test Tolerances..... 31

Standard Test Numerical Record 32

Test Method - Repeatability 33

Test Method - Cornerload..... 34

Test Method - Linearity..... 35

Standard Span Test Procedure..... 36

A&D..... 37

EK-H Calibration (EK-400H, EK600H, EK4000H, EK6000H) A&D..... 37

EK-G Calibration (EK series with "G" suffix) A&D..... 38

EW-G Calibration (EW series with "G" suffix)..... 38

EK-120, 1200, 12KA 39

EP/SP -- Calibration and Operation / A&D 40

ER / SP Calibration Re- Definition / A & D..... 42

ER-180, ER-120, SP-182 -- Linearity Adjustment / A&D..... 43

<i>FR Series-- Internal Calibration Weight Correction / A&D</i>	44
<i>FW -- Calibration / A&D</i>	45
<i>FX and FY -- Initialization / A & D</i>	46
<i>FX and FY -- Linearity & Calibration / A & D</i>	47
<i>GF Calibration / A&D</i>	48
<i>GX internal weight calibration adjustment</i>	49
<i>HA Series Calibration / A&D</i>	52
<i>HF Calibration & Linearity / A&D</i>	53
<i>HR Span Calibration , Cornerload Adjustment</i>	55
CAHN	56
<i>Packing and Unpacking Cahn Microbalances</i>	56
21 23 25 Calibration - Cahn.....	57
28, 29 Calibration - Cahn.....	58
<i>Model G -- Operating Instructions / Cahn</i>	59
<i>TA Series – Calibration & Transportation Arrestment / Cahn</i>	60
4100 -- Operating Instructions / Cahn	61
Denver Instruments	62
<i>A Series Analyticals -- Calibration / Denver Instruments</i>	62
A200DS -- Linearity / Denver Instruments	63
DI Series -- Linearity Correction Procedure / Denver Instruments	64
TL, DTL, 7xxx, 8xxx ,M, MX - how to tell what's what.....	67
TL-1600S -- Initialization and Calibration (old TL) / Denver Instruments	68
TR / TL (new) / TC Linearity	69
TL Calibration and Password (new TL series) – Denver Instrument.....	71
TR Calibration and Password – Denver Instrument	73
XA series -- Calibration and Linearity / Denver Instruments.....	74
XD/AC -- Linearity / Denver Instruments.....	76
XD-100A and Dual Display Analyticals -- Linearity and Calibration / Denver Instruments	77
XL/AL Series -- Calibration and Linearity / Fisher/Denver Instrument.....	78
AL Series with – 44 after model number	78
XP Calibration.....	79
XT and Z Series -- Calibration / Denver Instruments.....	80
XT and Z Series -- Linearity & Calibration / Denver Instruments	81
8301 -- Instructions For Operating In Counting Mode / Denver Instruments	83
METTLER	84
AC and PC -- Calibration and Linearity / Mettler	84

<i>AE-160/163 -- Calibration / Mettler</i>	85
<i>AE -- Linearity / Mettler</i>	86
<i>AE Display board exchange</i>	87
<i>AG -- Calibration and Menu / Mettler</i>	88
<i>AK, PK, and HK -- Calibration / Mettler</i>	89
<i>AT -- Calibration and Calibration Mode Selection / Mettler</i>	91
<i>AT -- Packaging and Glass Doors / Mettler</i>	92
<i>BD Calibration</i>	93
<i>BB -- Service / Mettler</i>	94
<i>HL Balances -- Checklist for Shipping / Mettler</i>	95
<i>LJ16 and LP16 Infra-Red Dryer / Mettler</i>	96
<i>ME30</i>	97
<i>M3 -- Calibration / Mettler</i>	98
<i>M3 and UM3 microbalance - packing for shipment</i>	99
<i>MT5 UMT5 Calibration</i>	100
<i>PB / AB / SB Calibration - Mettler (new style)</i>	101
<i>PB -- Calibration / Mettler (old type)</i>	103
<i>PB (old style) and PL Instruments -- Installation of HDSP / Mettler</i>	104
Replacement of digital display LED's	104
<i>PC -- Temperature Compensation / Mettler</i>	105
<i>PC -- Calibration and Linearity / Mettler</i>	107
<i>PC2000, PC4000, PC4400 -- Guides Made By IES Corp.</i>	108
<i>PE Lab Balances -- Calibration / Mettler</i>	109
<i>PE -- Pots & Boards / Mettler</i>	110
<i>PK, AK, HK -- Calibration / Mettler</i>	111
<i>PG, SG Calibration and menu blocks - Mettler</i>	113
<i>PG SG Calibration / Mettler</i>	114
<i>PM -- Configuration / Mettler</i>	116
<i>PM — Piece Counting / Mettler</i>	117
<i>PM, PJ, AM, AJ Balances -- Calibration and Error Codes / Mettler</i>	118
<i>PR / SR Calibration - Mettler</i>	119
<i>PT Calibration & Cornerload adj (Old-Style Mettler PT)</i>	121
<i>Installation of PML4 Linearity Board / Mettler</i>	122
PML4 Linearity Board Installation (continued) / Mettler PM Toploader Balance	123
Static Electricity	123
Installation of PML1 in High Capacity Instruments / Mettler.....	124
<i>XS Calibration Configuration - Mettler</i>	125
<i>XS Calibration, Internal, External - Mettler</i>	126
<i>XP Calibration Configuration - Mettler</i>	128

<i>XP Calibration, Internal, External - Mettler</i>	129
<i>Flexible parts pictures – for Mettler</i>	132
<i>Option 012 Circuit Board - Mettler</i>	133
OHAUS	134
<i>AP and AS Calibration</i>	134
<i>B-1500A -- Calibration / Ohaus</i>	135
<i>B3000 -- Calibration and Linearity / Ohaus</i>	136
<i>E Series -- Calibration and Linearity / Ohaus</i>	137
<i>G and GT Series -- Linearity and Calibration / Ohaus</i>	138
<i>Galaxy G160 and G110 -- Calibration / Ohaus</i>	139
<i>TS & TP -- Calibration / Ohaus</i>	140
<i>Explorer Calibration - Ohaus</i>	141
<i>Navigator Calibration - Ohaus</i>	143
<i>Voyager Calibration - Ohaus</i>	145
PERKIN-ELMER	146
<i>AD4 Microbalance -- Calibration / Perkin-Elmer</i>	146
PRECISA	147
<i>280 Series -- Calibration (Span) / Precisa</i>	147
<i>(PAG) 300 Series -- Linearization / Precisa</i>	148
SARTORIUS	149
<i>Letter Series -- Software Correction of Internal Calibration Weight / Sartorius</i>	149
Series A.....	149
Series E	149
Series H.....	149
Series I	149
Series L (see the separate article for LA, LP, LC).....	149
Series R.....	149
Series U.....	149
<i>B series -- Calibration & Linearity / Sartorius</i>	150
<i>BP Calibration -Sartorius</i>	151
<i>CP , GC series - Sartorius</i>	152
<i>EA and EB Calibration Adjustment - Sartorius</i>	153
<i>FC Calibration Adjustment - internal - Sartorius</i>	154
<i>FC Calibration & Adjustment – external Sartorius</i>	157
<i>FC Overwrite internal weight calibration – Sartorius</i>	159
<i>L series -- Calibration (not the same as LC series) / Sartorius</i>	160
<i>LA Calibration Adjustment - internal (not same as L, LC, or LP) / Sartorius</i>	161
<i>LA Calibration & Adjustment – external (not L, LC, or LP) Sartorius</i>	164

<i>LA Overwrite internal weight calibration – Sartorius</i>	166
<i>LA error codes – Sartorius</i>	167
<i>LC/AC Series (not the same as L series) -- Calibration / Sartorius</i>	168
<i>MC Calibration</i>	169
<i>LC/AC Series (MC1) Overwrite Internal Cal - Sartorius</i>	170
<i>MA30 -- Calibration / Sartorius</i>	171
<i>Menu System / Sartorius</i>	172
<i>Menu System (continued) / Sartorius</i>	173
<i>"PLUS" package programming</i>	174
<i>Menu Codes / Sartorius(older series)</i>	175
<i>PT1200, 600, 120, 6, QT -- Calibration / Sartorius</i>	176
<i>QC Calibration , error codes – Sartorius</i>	177
<i>QS Series Calibration & Linearity - Sartorius</i>	178
<i>RC Calibration</i>	179
<i>38XX Platforms -- Calibration / Sartorius</i>	180
<i>120x -- Calibration and Linearity / Sartorius</i>	181
<i>1364, 1303, and 1304 -- Adjustment / Sartorius</i>	182
<i>1400 MP8-1 -- Calibration & Linearity / Sartorius</i>	183
<i>1500's -- Calibration / Sartorius</i>	184
<i>1601 -- Calibration / Sartorius</i>	185
<i>2003 -- Calibration / Sartorius</i>	186
<i>2003 and 2004 -- Locking for Transportation and Unlocking for Use / Sartorius</i>	187
<i>2003 -- Packing Instructions / Sartorius</i>	189
SAUTER	191
<i>Sauter Platform Diagram</i>	191
<i>Lock Platform – Sauter</i>	192
<i>E3380 -- Calibration / Sauter</i>	193
<i>ED2180 and 2080 Multiscale -- Calibration / Mettler/Sauter</i>	195
<i>ED2180 and 2080 Multiscale -- Calibration (continued p. 2) / Mettler/Sauter</i>	196
<i>1200 and 1300 Series -- Calibration / Sauter</i>	198
SHIMADZU	200
<i>AEU-210 -- Calibration Weight Mounting / Shimadzu</i>	200
<i>BL Calibration – Shimadzu</i>	201
<i>UW Calibration – Shimadzu</i>	202
<i>UX Calibration – Shimadzu</i>	203
TOLEDO	204

ID SERVICE MODE / Toledo..... 204
 ID SERVICE MODE / Toledo--Linearity 205
 ID SERVICE MODE / Toledo--Calibration..... 206
ID1 -- Changing Unit 2 of Measure / Toledo 207
ID 5 – Changing or Selecting Unit 2 / Toledo..... 208
ID-SX Service Mode Notes 209

Who we are, what we do :

Who: We're IES Corporation. We're a company that specializes in the repair of lab balances and high precision scales. We're only a service company - or more particularly a *repair specialist*. We don't do on-site calibrations or sell new equipment.

What we do: We serve the repair needs of scale service companies and lab-balance specialists throughout the US. Typically, they need a source of repairs on this specialized equipment..

Why we're the best: You'll find that these facts truly distinguish IES from all others in the shop-service field:

- 1) **Service is our only business** Our future is based on your satisfaction with the repair service we provide. Since repair service is our only "product", it receives our highest priority. When you contrast that with other providers that are primarily in the business of selling new equipment (either as a manufacturer or a distributor) , you can understand that their companies are structured to a different purpose. We want to repair your instrument. At the highest levels, they don't.
- 2) **Experience.** We have repaired more lab balances than any other independent shop in the nation, and have more varied experience than any factory center. Over the past 25 years, we've repaired over 30,000 lab balances. No one else has comparable experience.
- 3) **We repair instruments that are no longer repaired by the manufacturers.** In many cases, this means that we manufacture components. We can perform repairs that are not available elsewhere. If you have equipment that you believe can no longer be repaired, give us a call.
- 4) This manual is just an example of the type of **technical support** we provide to our customers. We also provide telephone support toll free. Call whenever you need assistance with adjustments.
- 5) **Free repair quotations. One year warranty.** You can know the exact cost in advance of any repair. If your customer decides they don't want it repaired, we ship it back with no charge for the quote or shipping. See the quotation and warranty policies for details. (pages 10 and 11)

I sincerely believe there is no better value for your lab balance repair dollar anywhere in the US.

Respectfully,
Doug Morse, IES Corp.

About this book

This collection of service notes has been provided by IES Corporation, of Portland Oregon. It's purpose is to assemble many bulletins together in one volume, and thereby provide a reference of information to assist the technician. We sincerely hope that you will find it to be valuable and useful.

Many times, our customers call and want information about making a specific adjustment on a specific instrument. We do our best to provide assistance over the phone. Often, we write a summary of the question and answer, and file it for future reference. We can FAX those summaries in response to future questions. This manual is the aggregate of many of those summaries.

IES must specifically declare that the procedures contained within this manual may not be applicable, appropriate, accurate, or complete when applied either to specific instruments, families or groups of instruments, or manufacturers. IES accepts no responsibility whatever in connection with the distribution or application of the information contained herein. IES accepts no expressed or implied liability due to the contents of these service notes

This manual is in no way a replacement of factory repair manuals. IES highly recommends that all service be performed in accordance with factory repair documentation, and to the manufacturer's tolerances. The procedures outlined in this manual do not have the endorsement of any balance or scale manufacturer. Tolerances listed within this manual are the test tolerances at IES, and are not intended to represent manufacturer's tolerances.

Any unauthorized use or distribution of this manual and it's contents, without the prior written permission of IES, is expressly prohibited.

Instruments Repaired by IES

Please don't consider this list to be comprehensive. We repair many models that are not listed here – there isn't room to list the thousands of different models. If you don't see what you are looking for, just give us a call at 800 541-0852

Mettler-Toledo

PB, PR, PG
 PM, SM
 SB, SG
 AB, AC, AE analyticals
 AG, AT, HK analyticals
 PE, PC, PK
 XP, XS
 K platforms
 IDx indicators
 Sauter E series
 Microbalances
 moisture analyzers
 others

Sartorius

A, AC series
 B, BA, BP series
 F, H, I, L, Q series
 R analyticals
 2000 analyticals
 moisture analyzers

 1200-1800 : all
 3800 series
 LA, LC, LP
 FB, FC
 QS, QC

Ohaus

Adventurer, Explorer, Voyager
 AP, AS analytical
 G, GT, Galaxy
 TS, TP toploaders
 E series
 B series
 Navigator
 moisture analyzers
 too many to list !!

A&D

FX, FX, FY, FR
 HF, HX
 HA, HR, HM, GR
 ER, EP
 moisture analyzers
 others

Cahn

Denver / Fisher /

Ainsworth

too many to list !
 call

IMPORTANT

Lab balances and high-precision platforms can be damaged when shipped improperly. Call for packing instructions and our special (free) shipping cartons.

Galaxy and Ohaus are registered trademarks of Ohaus Scale Corp.

Repaired Instrument Warranty

IES Corporation guarantees that all parts and materials used in the repair of electronic weighing instruments, as well as the workmanship required to install those materials, will be free of defect for one year from invoice date. Additionally, any functional problem which is described is guaranteed to be corrected, and the stated malfunction shall not occur for a period of one year from invoice date.

IES will not be responsible for functional problems other than those reported to us and included in our quote. Damage due to mechanical abuse, chemical or water attack, or repair efforts of any party other than IES are not covered under warranty.

Please call IES prior to shipping instruments to us. This is the opportunity to establish a clear understanding of what malfunction caused the instrument to be removed from service, and what we are expected to repair. We will fax a Return Authorization to you immediately. The RA we fax (or e-mail) to you will give you a tracking number, a description of the malfunction, and any other details you may wish to include.

Our goal is to provide quality repairs at competitive prices with excellent support. Our biggest problem is that we do not get a description of the malfunction from our customer.

For any instrument returned to us for repair under warranty, IES will reimburse shipping charges when invoiced for transportation via UPS ground or similar. IES will return such equipment to the customer via ground carrier.

Quotation Policy

IES will supply a quotation for the repair of any instrument shipped to our repair facility in Portland Oregon. There is no charge for the quotation. Quotes are returned via email or FAX whenever possible, telephone otherwise. We make every effort to return quotes the same day the instrument arrives. No repairs will be made until the customer approves the quote. Repairs which have been quoted and approved will be invoiced exactly as quoted.

Repair quotations apply specifically to the repairs requested on the customer's incoming paperwork or detailed on the Return Authorization, and do not cover repairs other than those so described. Quotes normally include shipping charges. IES will ship via ground transportation unless instructed otherwise on the associated paperwork. Quotations are based on a visual appraisal of the instrument's condition, the repairs requested on the Return Authorization, and our experience with the particular instrument model. We inspect every instrument individually. We do not perform extensive electrical testing or mechanical repair prior to being authorized to do so.

Instruments which arrive at IES with a Purchase Order and instructions to repair without quote will be invoiced on a labor + materials + shipping cost basis. Since no quote is required, these instruments are repaired and returned without further communication.

We will discuss any instrument with you on the phone and make an estimate of the cost of repair. This allows you to determine a likely cost without shipping the instrument to us. Please understand that estimates are just that – estimates. We provide the best estimate we can with the information you provide.

Regarding Declined Quotes

For instruments under \$100 value and under 100 pounds weight, IES will return the unrepaired instrument via ground transportation at no charge whatever. To Alaska or Hawaii, we will return any unrepaired instrument for the cost of transportation. IES will insure these instruments for loss or damage up to \$100. For instruments valued over \$100, or for all instruments over 100 pounds, return transportation is paid for and arranged by the sender. You will communicate with your carrier (UPS, truck, etc.) and make payment arrangements directly with them. We will package your instrument or attach to a pallet at no charge, and make it available to your carrier.

Carriers such as FedX and UPS will pick up shipments at our location and bill to your account. Please advise us in advance if you are using these services, so that we can be ready for their pickup. Check with your carrier for details.

Return Authorization

When you are sending an instrument to IES, please call or email us. We will create a tracking number and document that summarizes the repair and logistics information. **This is the opportunity to get a clear mutual understanding of what the malfunction is, and what IES will be repairing.** We will fax or email the Return Authorization document to you immediately. We urge our customers to call ahead for an RA, since doing so adds organization, completeness, and clarity to these transactions. If you call outside business hours, please leave a message with your name, company name, model, and a description of the malfunction or reason the unit was removed from service. You can email anytime to doug@iescorp.com, or fax to 503 233-2926.

General Technical Articles

Calibration Weights , Frequently Asked Questions

Q. I did the "auto calibration" on the analytical balance . But when I check it with my weight, it still isn't right. I know my weight is accurate, since it's class 1, and we just had it calibrated. What can the problem be?

A. Your weight is erroneous, even though it's just been calibrated. Class 1 weights have errors just like all other weights, and those errors are easily measured on an analytical balance. The following table shows the nominal value, and both the high and low limits of class 1 weights

Nominal Value g	Maximum ASTM 1	Minimum ASTM class 1
10,000	10,000.02500	9,999.97500
5000	5,000.01250	4,999.98750
2000	2,000.00500	1,999.99500
1000	1,000.00250	999.99750
500	500.00125	499.99875
200	200.00050	199.99950
100	100.00025	99.99975

For example, the 100 gram weight can be as much as 100.00025 gram, and as low as 99.99975 gram , and still be within ASTM class 1 (formerly class S) tolerance. A standard analytical balance reads out to four decimal places. If we round the maximum and minimum to four decimal places, then the maximum reading is 100.0003, and the minimum is 99.9998. So any reading in this range is possible on a "perfect" analytical balance. Of course, if the instrument has any errors (they all do) , then those are additional.

Q. Wait a minute! Are you saying my class 1 weights aren't good enough ?

A. Right. An ordinary analytical balance is MORE accurate than those weights, and it will readout (measure) the difference between the internal calibration weight, and your external test weight. If you think your external test weight is correct, then you'd conclude that the internal weight is "off" . But how would you know whether your test weight is correct or not ? As the chart above shows, it can be ASTM class 1 , and still be way off.

Unless you have a calibration certificate that says what the actual value of your weight is, you'd be better off trusting the internal calibration weight. If your certificate says it's in tolerance , but doesn't specify the actual value , then trust the internal weight. You have no reason not to .

Q. If all weights are erroneous, how can I ever check the accuracy of my balance?

A. You'd have to have a calibration certificate for the weight. This would NOT be a certificate that just says that it's been checked and that it is within class 1 tolerance. It WOULD BE a certificate that says what the actual weight value is – gives you a number. If you are buying calibration services for your weights, be sure you understand the difference between a certificate that simply says the weight is in tolerance, and a calibration report that tells you precisely what the actual value of the weight is.

Q. What if I don't have a calibration certificate for my weight?

A. You can't guarantee that the balance is in tolerance. The reason the instrument manufacturers incorporate internal calibration weights into the instruments is so that they can make those weights more accurate than standard class 1 weights, and have the internal calibrations be more accurate than would result if class 1 weights were used. So, absent a calibration certificate and a VERY controlled environment (temperature controlled to within 2 degrees F , 24/7) you're better off trusting the internal calibration weight than your external weight.

Q. What is a weight "class" ?

A. A weight class is a specification that describes the accuracy of the weight. Some balances/scales are more accurate than others, and so demand that the weights used to calibrate them are more accurate. There are four ASTM weight classes (1-4) , with class 1 being the most accurate, and class 4 being the least.

Class 1 weights greater than 20 grams are accurate to one part in 400,000. But many lab balances are accurate to one part in 2 million. (example: 200 gram analytical balance that reads to .0001 gram resolution) Even OIML (Organization of International Metrology Labs) class E1 weights are only accurate to one part in one million.

Q. Why are there various weight classes?

A. As we've seen, the ordinary analytical balance is more accurate than class 1 weights, since it measures to parts-per-million (PPM) accuracy. But lots of top-loaders aren't so accurate, so it might be possible to use less accurate weights on those, and still have the weight be MORE accurate than the balance. But anyone who services lab balances needs the class 1 weights on some instruments, and you'll probably not want to carry a different weight set for every model.

Q. So I should use my class 1 weights everywhere?

A. No! In order to minimize wear , a less accurate weight can be very handy for some tests. The accuracy of the test weight is only critical in checking the CALIBRATION of the instrument. But checking REPEATABILITY, CORNERLOAD, and LINEARITY is done just as well with less accurate weights. The technician would do well to have some alternative weights (perhaps two 50 gram and two 100 gram), since these would get frequent use on analyticals, and save constant wear on the critical 50 and 100 gram calibrated weights.

Q. If weights wear, how can I be assured that my weights are accurate, even if I get a calibration certificate?

A. Only through meticulous care of the weight - protecting it from abrasion and corrosion. For critical weights, never slide the weight across the weighing pan. Instead, rest it gently at exactly the place on the weighing pan you want it to be (the center). Use a lifting tool or a cotton glove to handle the weight, never bare hands. By having the weight re-certified periodically, you would be able to see that the deviation that is happening between certifications is acceptable.

Q. How long is a calibration certificate valid?

A. There is no expiration date on calibrations of weights used for calibrating lab balances. A typical calibration interval is one year. If you examine the calibration certificates of the same weight over year long intervals, and find that the change is more than 1 PPM, then a more frequent interval should be considered.

Drifty Analytical Balances

Definition: An analytical balance is one that measures to a ten-thousandth (.0001) or hundred-thousandth (.00001) gram. Capacity is in the range of 30-200 grams. These instruments have sliding glass doors to prevent air drafts.

Users and technicians often encounter units which are unstable or drifty. Often, it's not apparent whether the source of the instability is an instrument malfunction, or is caused by some environmental influence around the instrument. Almost all units normally wander a couple or more "counts" in the last decimal place. The best standard of comparison is an experienced user, who knows how the instrument has been operating previously. If the driftiness is more than usual, then there is either something wrong with the environment, or there is an instrument malfunction. There are four factors to consider before concluding that the source of drift is an instrument malfunction.

- 1) Since these instruments measure to parts per million accuracy, they are highly sensitive to temperature changes. **The room temperature needs to be constant around the clock, and the instrument needs to be "powered up" in the stable air temperature for 24 hours before full stability is achieved.**
- 2) Even though these instruments have glass doors, air drafts can cause problems. Air drafts can be caused by sources of heat or strong light. You can test by placing a large cardboard box over the instrument, with a little cutout hole to view the digital display. If placing the box over the instrument causes it to become more stable, then air drafts are a problem.
- 3) A static electric charge on any object causes a force of attraction or repulsion on all other objects. This is why lint sticks to clothing, and why plastic film clings to kitchen utensils. The force exerted by static charges is measurable by an analytical balance. **When items near an analytical balance are charged, a force is exerted on the weighing pan. Since static electricity discharges spontaneously, the force exerted changes too, and appears as drift.** You can test for static influence by placing a metal enclosure (coffee can) over the weighing pan so that the can encloses the pan, but doesn't touch it. Simultaneously touch the can and a grounded object to establish zero charge on the can. Thereafter, electric fields will be highly reduced by the can. If placing a grounded metal surface (can) over and around the weighing pan causes the readings to stabilize, then static electricity is a problem. Minimize static electricity routinely by avoiding plastic lab utensils and containers. Do not replace broken glass doors with plastic ones. Synthetic shoe soles (Vibram) causes static charge on people, especially on Linoleum floors. These problems are worst when the humidity is low.
- 4) An unstable table or floor will allow the instrument to move minutely as persons walk by or lean on the table. Test for this influence by eliminating all motion in the vicinity of the instrument.

Even under the best conditions, most analytical balances wander a few digits. Older instruments are a little more prone to this wandering than some modern ones, which use a microprocessor to suppress very small changes.

Linearity

Two mistakes are often made when testing lab balances. The result is that instruments are removed from service unnecessarily. The problems are (1) linearity, and (2) instability, or drifting. This article pertains to linearity testing, and how to properly test it. See the companion article *Drifty Analytical Balances* for information about unstable analytical balances.

The word *linearity* refers to consistent (equal) sensitivity through the range of weighing capacity. If we were to make a graph of applied weight vs. displayed weight indication, and the scale were perfectly linear, then the graph would be a *straight line*. Any deviations from perfect accuracy would make the graph-line somewhat curved.

For many scales, it's possible to simply test the scale at weights between zero and full scale, and see if the readings are correct. The reason this method works for many scales is that the test weights themselves do not introduce any error that is large enough to be detected by the scale. Said another way, the weights are more accurate than the scale, and the deviation from exact value in the weights is so small as to be unmeasurable.

The situation is reversed for many top-loader lab balances, and all analytical balances. Analytical balances resolve parts per million, but even the best common weights (ASTM class 1) are accurate to only parts in hundreds of thousands. So the reading from these instruments shows the error in the weights in addition to any linearity error that originates in the instrument. *We need a test method to see just the error caused by the instrument - a method that does not depend on the accuracy of the weights.*

For the purposes of this article, we're going to test a 200 gram capacity balance that reads out to .000 1 gram. We will use two 100 gram weights. It does not matter that the weights are accurate, but **it is essential that we distinguish one from the other and not accidentally interchange them in this procedure.** We'll call one "A", and the other "B". Hypothetical readings we might get are placed in ().

1. Rezero. (0.0000 g)
2. Place A on the pan (100.0002 g) write down the reading
3. Remove A. Place B on the pan. (99.9999)
4. Rezero (0.0000 g)
5. Place A on the pan. (100.0003 g) write down the reading
6. Subtract the reading at 5 from the reading at 2. [100.0002 - 100.0003 = - 0.0001] The result is the linearity error. Compare this error to the maximum error allowed to judge whether the instrument is operating satisfactorily. If the result is zero, the linearity is perfect. Any difference between the two readings is due to the instrument , not the weights, since we have weighed the same object both times. Notice that **only the difference between the two numbers is relevant to linearity, not the numbers themselves.** What we are doing here is comparing the reading of a given object (weight A) with and without a "preload".

The above linearity test procedure works for different capacity instruments. For a 100 gram capacity instrument, you'd need two 50 gram weights. For a 30Kg capacity high resolution platform, you'd need two 15Kg , or maybe three 10Kg. In any case, the idea is to compare readings of an individual weight with and without preload. When that method is used, the accuracy of the test weights makes no difference.

Cornerload

Cornerload refers to an instrument's ability to indicate consistently at all positions within the weighing pan. Generally, it is adjusted by observing readings as a test weight is re-positioned across the weighing pan. Adjusters, which vary the vertical position of the flexible arms (guides, flexures, etc.) are used to compensate the errors.

Although instruments vary, the principle of adjusting the mounted corners of the guides, in order to achieve acceptable cornerload performance, is nearly universal. The following method has been found to be useful generally.

In the diagram below, the weighing pan, flexible arms, and cornerload adjusters are shown. Regardless the name or form of the flexible arms, they are anchored beneath the cornerload adjusters. Rotating the adjuster changes the vertical position at which the flexible arm terminates.

The instrument is tared with the weight at "A", so that the readings at "B" and "C" are deviations from 0.00. Deviations at "B" are adjusted via hex #1, deviations at "C" via #2.

When the deviation at "B" is +, then the mounting at position #1 must move downward. Commonly, it is necessary to loosen a lock-nut, rotate the adjuster slightly, then retighten the lock-nut. Conversely, a - deviation calls for an upward repositioning. Errors at position "C" are corrected with adjuster #2.

The process of correcting cornerload errors requires several iterations of the above process. A set of readings after each adjustment reveals the worst error (at either B or C). The larger of the two deviations should always be adjusted next, until the remaining errors are within tolerance.

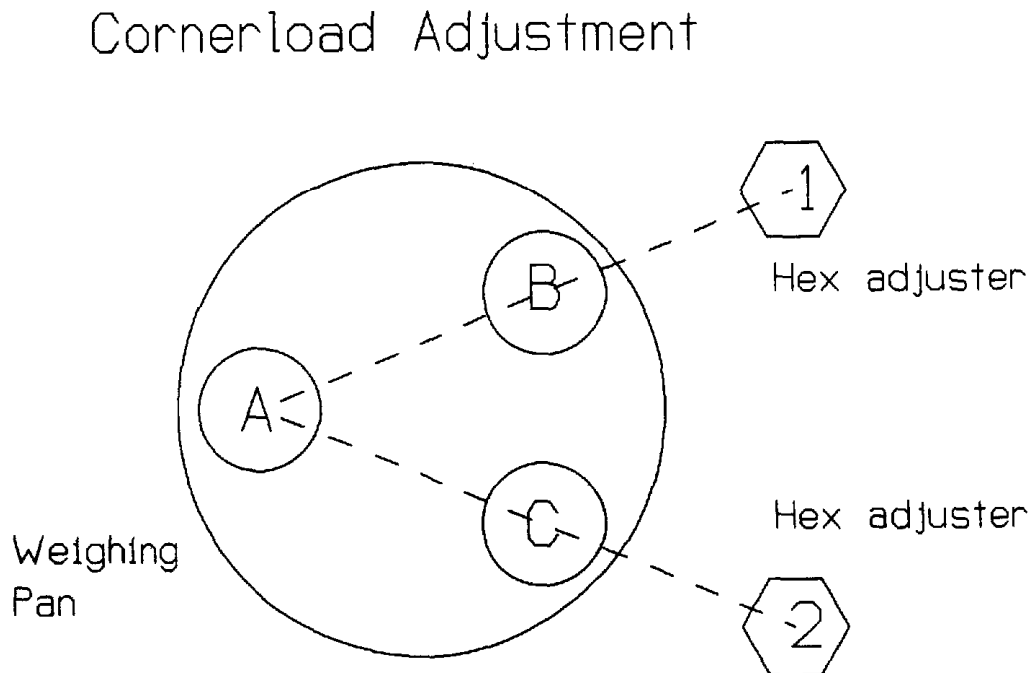

"Monobloc" Cornerload Adjustment

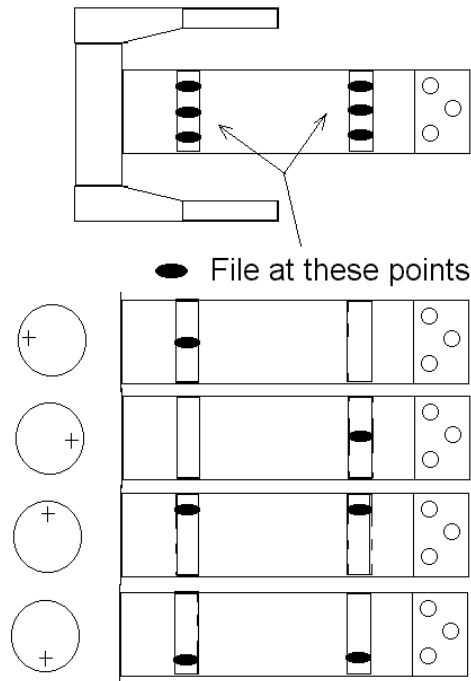

Monobloc Cornerload Adjustments

Several manufacturers now use one-piece cells, fabricated from a single aluminum block. Although this might be cheaper to manufacturer, the result is a cell structure that can only be adjusted for cornerload by filing away the flexible sections. If the flexible sections are distorted by accident or by overloading, the whole cell has to be replaced, generally at huge cost.

Do NOT file right on the outside edge of the monoblock

Do NOT try to use a flat hand file .

Be sure to clean out any filings with a vacuum.

Use a oval rotary burr such as Nicholson 4R3G in an electric drill.

Use a chart to record before and after readings. You must be able to see your before and after readings in order to **know** that the cornerload is getting better as you make adjustments. If you don't use a chart, you could go back and forth between making improvements and then anti-improvements, and end up with a ruined \$1000+ cell.

Be careful. You can ruin the whole cell easily. Cost of the cell is likely way over \$1000. Consider sending it to IES .

Cornerload Adjustment Chart

	Left Side Error	Left Side Adjustment	Right Side Error	Right Side Adjustment
1				
2				
3				
4				
5				
6				
7				
8				
9				
10				
11				
12				
13				
14				

Make _____ Model _____ SN _____
 Tolerance _____ Pass () Fail ()
 Technician _____ Date _____
 Test Weight ID _____

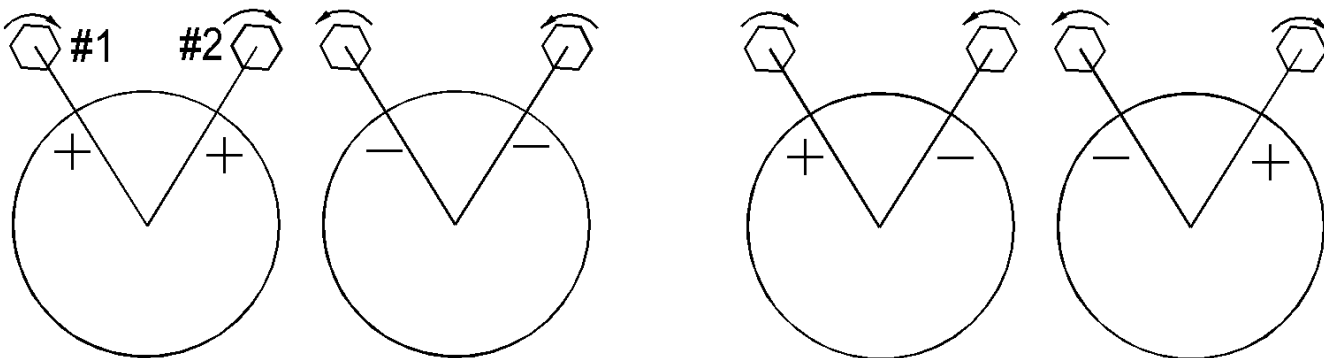

Weight Tolerances

This table shows the limits of actual values for various weights in various accuracy classes.

	Upper Limit	Lower Limit
Weight (gram)	ASTM Class 1	(like class S)
100	100.0003	99.9998
200	200.0005	199.9995
300	300.0008	299.9993
500	500.0013	499.9988
1000	1,000.0025	999.9975
2000	2,000.0050	1,999.9950
3000	3,000.0075	2,999.9925
5000	5,000.0125	4,999.9875
	ASTM Class 2	
100	100.0005	99.9995
200	200.0010	199.9990
300	300.0015	299.9985
500	500.0025	499.9975
1000	1,000.005	999.995
2000	2,000.010	1,999.990
3000	3,000.015	2,999.985
5000	5,000.025	4,999.975
	ASTM Class 3	
100	100.001	99.999
200	200.002	199.998
300	300.003	299.997
500	500.005	499.995
1000	1,000.01	999.99
2000	2,000.02	1,999.98
3000	3,000.03	2,999.97
5000	5,000.05	4,999.95
	ASTM Class 4	(like class P)
100	100.002	99.998
200	200.004	199.996
300	300.006	299.994
500	500.010	499.990
1000	1,000.02	999.98
2000	2,000.04	1,999.96
3000	3,000.06	2,999.94
5000	5,000.10	4,999.90

Linearity Adjustment Chart

	Adjustment	Zero to Half Scale	Half Scale to Full Scale
1			
2			
3			
4			
5			
6			
7			
8			
9			
10			
11			
12			
13			
14			
15			
16			
17			
18			
19			
20			

The Force Restoration Principle

There are two types of weight detecting mechanisms in common use within scales; strain-gauge based load cells, and the feed-back dependent force restoration cells. Strain gauges are limited in their accuracy to about 1 part in 5000, because the resistive elements and the substrate itself have non-linear effects. The force-restoration system has limits too, but there are many laboratory and industrial scales using that system, and accuracy can be as much as one part in several million.

The diagram below illustrates the concept. A weighing platform is mechanically suspended by a system of flex arms. Those flex arms restrain the platform from moving horizontally, but do allow a very limited vertical movement. Counteracting the vertical force is the force exerted by a coil. If a weight is applied to the platform, the system moves downward. This movement is detected by the null detector (light source and sensor), and results in a signal applied to the feedback electronics. In conjunction with that, the coil driver adjusts the current flowing in the coil, which adjusts the amount of force exerted by it. The effect is that the system tends to return to its original position. By measuring the amount of current required to return the system to the null position, the applied weight is measured indirectly. This is indicated by the digital readout.

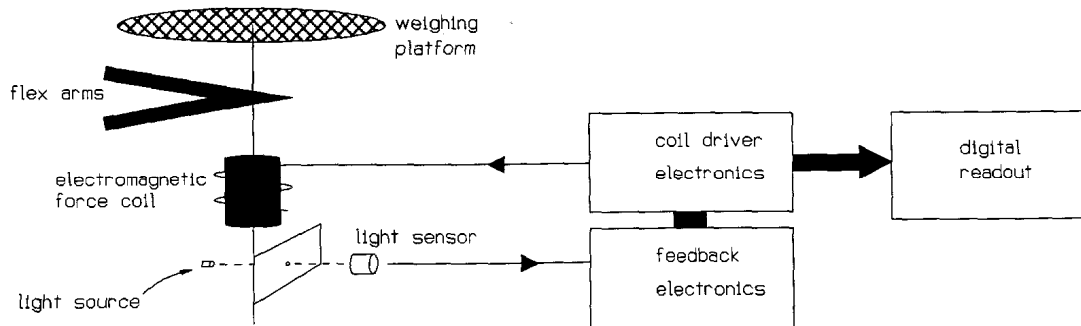

In practice, the "flex arms" are rigid struts, supported by flexible bearings. They may be a complicated system of mechanical parts, which both secure the platform horizontally, and provide some mechanical advantage (a fulcrum) between the platform and the force coil.

Also as a practical matter, the coil generally moves within a stationary magnetic field, although that isn't clear in the diagram. The coil is connected to the coil driver electronics via very carefully mounted flexible gold wires. Like all of the mechanism, those wires must move without friction, or the resolution and accuracy of the system are compromised. The mechanical components are aligned carefully.

Packaging Lab Balances for Shipment

Top Loader Types – Use a box with room for at least 3 inches of cushion material on all sides , more if possible. If possible, double-box. If the instrument uses a wall-mount AC adapter, include it with the instrument, but in a location where it can do no damage if it moves. Don't send ordinary 120 volt power cords. Include the IES Return Authorization (or a copy) with the instrument. Remove the weighing pan from it's normal position (and sub-pan, if present) , and include it in the box

Analytical Balances - Remove the weighing pan. Wrap it in bubble-pack and place the wrapped pan in the weighing chamber. Use enough bubble material that the pan is fully cushioned and has little range of motion in the chamber. Tape the doors closed with masking tape. Use a box large enough to include at least 3 inches of cushion material on all sides – more if possible. IES has a special box made specifically for analytical balances. Call us if you need one. If the instrument uses a wall-mount AC adapter, include it in the box in a place where it cannot break any part of the instrument, such as glass doors.

Mettler AT, AX Types, and all **Microbalances** - Call before shipping for special instructions for your particular model.

If you have any question about how to pack your lab balance, please call us at 800 541-0852.

The Truth about Shipping Damage

It's not often that I write an article in the Handbook that bears bad news. I'd rather not have to tell our customers that poor packaging has caused their instrument to be damaged in transit to us. The result is always the same: The cost of the repair is double or more the amount that it would have been. The reason is that the person who packed it used a box that was barely large enough to fit the instrument, so there was no room for cushion material.

If you are trying to save money on packing and shipping, please think again. If you take a chance with the customer's equipment, you can only loose. If the instrument is too expensive to repair and comes back with broken glass or cracked chassis parts, it reflects badly on you. It's a risk you don't have to take. **Keep a big box on hand so you don't get pressured into taking this risk.**

Always ship lab balances with the weighing pan (and sub-pan) removed from their normal position. They need to be included separately in the box with the instrument.

The cost of the damage in transit often is more than the cost of repairing the problem that caused the instrument to be removed from service. It's worth the time and money to pack well. This memorandum is now printed automatically with all Return Authorizations.

Static Electricity and Drifty Lab Balances

A lot has been written about static electricity and its effects on electronic circuits. Let me say at the beginning that this article is NOT about power surges or damage to circuits. It is about the fact that static charges on things like people, plastic articles, and even the object being weighed exert a force, and that many lab balances can readily detect those forces. The result is erratic readings, since the force isn't steady.

Anyone who has ever had lint stick to clothing has witnessed the force exerted by a static charge. Another example is clothes coming out of the dryer, which cling to each other. The force which attracts these things is caused by static electricity, and it is readily detectable by instruments with resolution of .001 gram or less.

Any object will become charged as it moves through the air or rubs against another surface. How much charge is developed depends on what the materials are, and whether they have a conductive path through which to dissipate the charge. Materials which are really good insulators, like plastic, can easily receive and hold a substantial charge. In dry weather (winter) there is little moisture to provide a conductive path for discharge, and the problem is worse then.

Every object with a charge on it exerts a force on everything around it. The amount of force depends on the size of the object, what it's near, how much charge etc. Examples of things that can cause problems with analytical balances are:

- Charged people
- Charged object being weighed
- Plastic draft shield
- Charged object in the weighing chamber

If readings on analytical or micro balances are unstable, then you might want to try removing static, and see if things stabilize. To do this, wash the windows of the draft chamber (inside and out) with glass cleaner, but leave them damp. Discharge yourself to ground by touching the chassis of the instrument, or any grounded object.

If you do have trouble with static, then you may want to take some of these steps:

- Humidify the air
- Remove carpets, and wear conductive shoes
- Get an air ionizer or StaticMaster (scientific supply companies)
- Remove or replace plastic objects with metal
- Provide static discharge paths for objects and people

Placing a metal enclosure (such as a coffee can) over the pan of an analytical balance will shield the weighing pan from static electricity stored on the person using the balance, or stored on the glass doors. It will not eliminate problems induced by static on the object being weighed. The can must have its open end down, and not touch the weighing pan at all.

Moisture Balances - Practical Considerations

Moisture balances are typically used to measure the percentage of moisture in samples. They do so by heating the sample, and automatically calculating the percentage of weight lost throughout the heating cycle. Often, users of these instruments find that a given temperature and time setting on one model of dryer doesn't cause the same percent moisture loss as the same settings on another model. This article explains why that is, and how consistent results can be obtained.

Three physical factors effect the performance of moisture analyzers:

- a. Optical/radiant characteristics of the sample and the heater.
- b. The mass and dimensions of the sample being analyzed.
- c. The proximity of the temperature sensor to the sample being analyzed.

These dryers heat the sample by radiating infra-red light onto the sample. As the light strikes the sample, the light turns to heat, and is conducted throughout the sample. The degree of light absorption is effected by the color and surface characteristics of the sample, as well as the color of the light compared to the color of the sample. Different dryers use different heat sources, and so will heat a given sample type in different ways.

The light from the heat lamp strikes the surface of the sample and turns to heat at the surface. Heat is conducted to the interior of the sample at a rate determined by the mass and size of the sample. In any case, the surface is hotter than the interior as long as the light is striking the surface. There is no single temperature number (including the temperature set on the control panel) that describes the temperature of the sample, since the temperature is a gradient throughout the sample

The temperature sensor is typically not touching either the surface of the sample, or the interior of it. And since it does not have the exact same heat-absorbing characteristics as the sample, it is at a somewhat different temperature than the sample. Remember that the temperature regulation function of the analyzer is controlling the temperature of the sensor, not the sample. The two are related, but not identical.

For the above reasons, different models of moisture analyzers set to the same time and temperature would evaporate different amounts of moisture, and would heat the sample differently , unless the settings are such that *all* of the moisture is removed.

What should be uniform between various analyzers is that they yield the same percent of moisture from a uniform set of samples *when dried to completion*. In order to completely dry a sample, different analyzers may take different amounts of time. Unless the heat intensity is set so high that the sample burns, higher or lower temperatures will only effect the amount of time required for complete drying. The key to getting uniform readings from different models of analyzers is to dry to completion.

If the drying process does *not* go to completion, then the amount of moisture lost in a time interval will depend on all of the above factors. Identical models should give similar results. Different models set to the same settings will evaporate different amounts of water in the same time interval, and give different results.

Standard Field Service

We are often asked to provide a description of a standard field service for lab balances. The following pages are our best effort at describing such a service. You are welcome to transcribe the procedure to your own document. It consists of:

- a. Description of Service.
- b. Service Record - a form that can serve as a record of performing the steps.
- c. Generalized Test Tolerances.
- d. Test Methods.

There is no intention that this procedure will be complete in every context. You will need to add, remove, or change steps to suit your customers and their particular needs. You can obtain a copy of this Standard Field Service in WORD word-processor format, for the purpose of editing , by submitting a request via e-mail to doug@iescorp.com , with subject "IES Handbook" .

One particular area that may be helpful is the Generalized Test Tolerances. Most lab balances are guaranteed to meet their advertised performance specifications ONLY if certain environmental conditions are met. Usually, the conditions are not met . That leaves the service company with the job of judging what is, and what is not, acceptable measurement performance. At the same time, structured quality systems (ISO) may demand that actual performance be compared to a written standard.

The Generalized Test Tolerances are our effort to establish a written standard that can be referenced in the absence of other applicable performance standards. The Service Record form can be completed relative to these tolerances , or tolerances that your customer may supply.

Description of Service

Our service consists of the following steps

- 1 Clean the instrument as needed and practical.
- 2 Confirm control functions are operative.
- 3 Test and confirm Repeatability per written test method.
- 4 Test and confirm Cornerload Accuracy per written test method.
- 5 Test and confirm Linearity per written test method.
- 6 Calibrate to external standard, or internal standard if applicable.
- 7 Document the above as provided on the Service Record

Service Record

Model _____

SN _____

Date _____

Technician _____

Test Weight ID# _____

Performance Criteria

Generalized Test Tolerances

Customer specified

Government regulatory agency _____

Other _____

Numerical Test Data Required at steps 3-6 under contract : yes no

- | | | | |
|----|---------------------|-------------------------------|---|
| 1. | Clean | <input type="checkbox"/> pass | <input type="checkbox"/> fail |
| 2. | Controls Functional | <input type="checkbox"/> pass | <input type="checkbox"/> fail |
| 3. | Repeatability | <input type="checkbox"/> pass | <input type="checkbox"/> fail |
| 4. | Cornerload | <input type="checkbox"/> pass | <input type="checkbox"/> fail |
| 5. | Linearity | <input type="checkbox"/> pass | <input type="checkbox"/> fail |
| 6. | Calibration (span) | <input type="checkbox"/> pass | <input type="checkbox"/> fail <input type="checkbox"/> adjusted |

Generalized Test Tolerances

Tolerances are expressed in digits – the smallest increment of indication the instrument is capable of. These tolerances apply to repeatability, cornerload , and linearity.

Lab Environment Tolerances (digits)
(documented temperature stability less than 2° C uninterrupted)

Resolution	.1 g	.01 g	.001 g	.000 1g	.00001 g
Capacity, up to					
30 gram	-	-	-	2	4
100 g	-	-	2	3	6
300 g	-	2	3	6	-
1000 g	2	3	4	-	-
3000 g	3	4	-	-	-
10 Kg	4	-	-	-	-
30 Kg	12	-	-	-	-

Industrial Environment Tolerances (digits)

Resolution	.1 g	.01 g	.001 g	.0001 g	.00001 g
Capacity, up to					
30 gram	-	-	-	4	10
100 g	-	-	4	6	20
300 g	-	4	6	8	-
1000 g	4	6	8	-	-
3000 g	6	8	-	-	-
10 Kg	8	-	-	-	-
30 Kg	24	-	-	-	-

Standard Test Numerical Record

Make _____
 Model _____
 SN _____
 Technician _____
 Date _____

Repeatability

As found	
Adjusted	

test weight ID _____

Cornerload

	Front	Right	Rear	Left
As found				
Adjusted				

test weight ID _____

Linearity

	A only	A increment over B
As found		
Adjusted		

test weight ID A _____

test weight ID B _____

Calibration

	Full-scale reading
As found	
Adjusted	

test weight ID _____

Test Method - Repeatability

Select a single test weight of nominal value at least 50%, but not more than 100% , of the weighing capacity of the instrument. Start with the weighing pan empty. Rezero. Alternately place and remove the test weight ten times. If the instrument reproduces both lower and upper readings with variation less than the allowed tolerance all ten times, then the instrument passes the repeatability test.

Poor repeatability can be caused by an inadequate operating environment. Units which pass the test under conditions of

- continuous (24 hour) environmental temperature control
- lack of floor vibration and air movement
- continuous power-ON
- lack of static electricity sources

but which fail the test under existing circumstances should be considered to have passed the repeatability test. Verify performance on the **Service Record**, or if required, on the **Standard Test Numerical Record**.

Test Method - Cornerload

1. Select a single test weight of nominal value at least 50% , but not more than 100%, or the weighing capacity.

2. Place the test weight in the center of the pan, then rezero.

3. Move the test weight so that it's center is half way from the center of the pan to the periphery at the front, right, rear, and left.

4. Verify operation to be within tolerance.

Verify performance on the **Service Record** , or if required, on the **Standard Test Numerical Record**.

5. If any reading exceeds the tolerance, then the instrument is "non-performing". It should either be adjusted into conformance, or marked "non-performing"

Test Method - Linearity

1.

Select two weights of standard nominal value as close as possible, but not greater than, one-half the weighing capacity of the instrument under test. Segregate these test weights as weight A and weight B. It is permissible to use a group of weights, rather than a single weight, to represent weight A.

2.

Place weight A on the weighing pan. Record the reading.

3.

Replace weight A with B, and rezero.

4.

Place weight A on the weighing pan with B. Record the reading.

5.

The readings at steps 2 and 4 should match within the linearity tolerance. Notice that there is no requirement to produce a specific reading; only that the two readings match each other within the tolerance. Verify operation to be within tolerance. Verify performance on the **Service Record**, or if required, on the **Standard Test Numerical Record**.

Standard Span Test Procedure

1.
Select a standard test weight of nominal value as close as possible, but not greater than, the instrument weighing capacity.

2.
Place the test weight on the weighing pan. Adjust as required to bring performance within tolerance. Verify performance on the **Service Record**, or if required, on the **Standard Test Numerical Record**.

A&D**EK-H Calibration (EK-400H, EK600H, EK4000H, EK6000H) A&D**

- 1) Warmup at least one half hour.
- 2) Press and hold SAMPLE and PRINT keys until “CAL out” shows on the readout.
- 3) Wait for the readout to show “ CAL 0”
- 4) Press and release PRINT key.
- 5) Wait for the instrument to show a required calibration weight value.
- 6) Place the indicated weight value on the weighing pan, then press and release PRINT.
- 7) Wait for END to show on the readout
- 8) Remove the calibration weight.
- 9) The instrument returns to weighing mode .

EK-G Calibration (EK series with “G” suffix) A&D**EW-G Calibration (EW series with “G” suffix)**

- 1) Start with power ON and weighing pan empty.
- 2) Locate the cover on the rear which encloses the CAL switch.
Press the CAL switch. The instrument goes into CAL mode. The current gravity setting is displayed on the readout.
- 3) Press ENTER. The readout shows “CAL 0”
- 4) Wait for the stability indicator (small circle in the upper left corner of the readout) to appear, then press ENTER.
- 5) The instrument will indicate a calibration weight value on the readout. Place that weight on the pan.
- 6) Wait for the stability indicator, then press ENTER
- 7) Wait for the readout to show “End”.
- 8) Remove the weight from the weighing pan. Press the CAL button.

EK-120, 1200, 12KA

1. Move the calibration switch to ON. (Behind right cover on EK120 & EK1200, behind left plug on EK12KA) Simultaneously press MODE and RE-ZERO.
2. After CAL 0 appears on the display, wait for stability, then RE-ZERO momentarily.
3. After CAL F shows, put the calibration weight on the pan (100, 1000, 10Kg, depending on model).
4. Press RE-ZERO. "END" will show on the display.
5. Remove the calibration weight, then press "MODE". Move the calibration to the OFF position.
6. If the digital display shows CAL E, then either the wrong calibration weight was used, or the instrument is in need of repair.

EP/SP -- Calibration and Operation / A&D

Available units are	Grams	g
	Percent	%
	Pieces	p.c.
	Pounds	lb.
	Pounds & Ounces	lb. & oz
	Ounces	oz.
	Troy Ounces	ozs t.

To change units

- a) turn unit OFF
- b) Press and hold MODE, then press ON, then release MODE.
- c) Repeatedly press MODE until the desired units show on the display.
- d) Press " % SAMPLE " key to select desired alternate unit of measure, OR proceed to step f if no alternate is desired.
- e) Repeatedly press MODE to select alternate unit of measure.
- f) Press TARE when finished.

Span Calibration

- a) Turn unit ON. Press RE-ZERO.
- b) Slide calibration switch down. < display: CAL 0 >
- c) Press RE-ZERO. Wait for display to show < CAL F >
- d) Place the calibration weight on the pan, then press RE-ZERO
- e) Wait for < CAL End > , move the calibration switch up.

Linearity

- a) Turn instrument OFF
- b) Press and hold RE-ZERO, while turning instrument ON.
Release RE-ZERO.
- c) Slide the calibration switch down (on).
- d) The display will cycle through various indications. When it gets to " Lnr ", press the RE-ZERO. Wait for Lnr 0 indication.
- e) Press RE-ZERO, and wait for Lnr 1. Place the first linearity weight (see page A.2) on the pan, wait 5 seconds, then press RE-ZERO.
- f) Wait for Lnr 2 indication, remove the first linearity weight and then place the second linearity weight on the pan. Wait 5 seconds, then press RE-ZERO.
- g) Wait for Lnr F indication, then place the both linearity weights on the pan. Wait 5 seconds, then press RE-ZERO.
- h) The instrument will automatically return to the cycling mode. When it does, return the calibration slide switch to it's normal position.
- i) Press ON/OFF twice

(Continued next page)

EP/SP -- Calibration and Operation / A & D (continued)

Instrument	Lnr 1	Lnr 2	Lnr F
20KA	10 Kg	10 Kg	20 Kg
40KA	20 Kg	20 Kg	40 Kg
60KA	30 Kg	30 Kg	60 Kg
12KA	5 Kg	5 Kg	10 Kg
41KA	20 Kg	20 Kg	20 Kg
22KA	10 Kg	10 Kg	20 Kg

Note that most instruments use the same weight at Lnr 1 as at Lnr 2.

ER / SP Calibration Re- Definition / A & D

Proceed ONLY after Cornerload and Linearity have been adjusted to specifications.
CALIBRATE BALANCE and verify calibration correction needed.

Re-Define as follows,

- 1) Tare balance then place 100.0000g EXTERNAL standard weight on pan.
- 2) Tare balance then REMOVE weight .
- 3) Drop INTERNAL calibration weight.
- 4) Write down the number on the display with sign.
- 5) Lift calibration weight and tare balance.
- 6) Write down current positions of DIP switches 1-6
- 7) Set switch 5 ON .(down position)
- 8) Press CAL
- 9) Set switch 6 to ON (down position) if number in step #4 is NEGATIVE
Set switch 6 to OFF (up position) if number in step #4 is POSITIVE
- 10) Set DIP switches 1-4 to match the number in step #4 using chart below .

Number from step #4	Dip Switch 1-2-3-4	(0 = OFF , 1 = ON) (ON is in the down position)
1	0 1 1 1	
2	1 0 1 1	
3	0 0 1 1	
4	1 1 0 1	
5	0 1 0 1	
6	1 0 0 1	
7	0 0 0 1	
8	1 1 1 0	
9	0 1 1 0	
10	1 0 1 0	
11	0 0 1 0	
12	1 1 0 0	
13	0 1 0 0	
14	1 0 0 0	
15	0 0 0 0	

- 11) Set DIP switch 5 OFF . (up position)
Display will show new calibration number then DIP switch positions.
- 12) Return DIP switches to those recorded in step #6
- 13) Press TARE then CALIBRATE , verify accuracy with EXTERNAL STANDARD ..

ER-180, ER-120, SP-182 -- Linearity**Adjustment / A&D**

Linearity:

- 1) Turn ON and warm up 30 minutes, then press ON/OFF to turn OFF the display.
- 2) While pressing and holding CAL and TARE, press ON/OFF. (don't let up on CAL and TARE yet) Continue pressing TARE, release CAL, then quickly press it twice.
- 3) Release TARE. The display should go to "8.8.8.8.8.8.8". Press CAL once immediately.
- 4) The display goes to "Lnr in". Wait for the display to proceed to "Lnr 50" . Place an accurate 50 gram weight on the pan, and wait 20 seconds for the instrument to stabilize internally, then press TARE.
- 5) Display will show "Lnr 100" . Remove the 50 gram weight and place an accurate 100 gram weight on the pan. Wait 20 seconds for stability, then press TARE. The display will go to "Lnr 150" .
- 6) Place the 50 gram weight with the 100, for a total of 150 grams, allow 20 seconds, then press TARE. The display will show "Lnr" , then "Lnr End"

Calibration

- 1) Plug in and warm-up to stability. Turn on and TARE. Display reads "0.0000g". Press CAL.
- 2) The display will show "CAL in", then "CAL" , then "CAL dn" . Use lever to lower the internal calibration weight.
- 3) The display will go to "CAL, then "CAL uP. Use the lever to remove the internal weight. The instrument will go to "CAL", then "CAL End".

Special Notes:

- 1) If the instrument doesn't go into the linearity mode, it's probably because you aren't doing steps 1 and 2 quickly enough. These instruments seem to be sensitive to how fast the technician performs those steps. Keep trying.
- 2) The procedures in A&D's book (pages 7 and 27) seem to be contradictory. The procedure above works.

FR Series-- Internal Calibration Weight**Correction / A&D**

- 1) Press CAL. Internal calibration will be performed.
- 2) When it returns to weighing mode (0.0000), turn display OFF.
- 3) Press and hold CAL & RE-ZERO.
- 4) Turn on. While still holding RE-ZERO, release CAL and immediately tap CAL twice (model # is displayed.)
- 5) Press MODE repeatedly until C-6 is displayed.
- 6) Press RE-ZERO (reference number is displayed.)
- 7) Press CAL (calibration weight is displayed.)
- 8) Press RE-ZERO (CAL 0 is displayed.)
- 9) With no weight on the pan, press RE-ZERO (CAL F is displayed.)
- 10) Place calibration weight on pan. Press RE-ZERO.
- 11) When display shows CAL END, remove weight.
- 12) Press PRINT. The internal calibration weight will go up and down a few times and then a new reference number will be displayed.
- 13) Press ON/OFF twice to return to weighing mode.

[7/12/00]

FW -- Calibration / A&D

1

Familiarize yourself with these instructions, so that the whole procedure is done within 3 minutes. Otherwise, the scale may go into the "AUTO-OFF" mode. Warm up the scale for 10 minutes by turning ON the scale, but being sure to change the load on the pan every 2 minutes. This will maintain the instrument in the ON state.

2

With display ON, tilt up the weighing platform. Find and remove the CALIBRATION SWITCH COVER. This cover is on the underside of the tilt-up portion, toward the center. Move the switch to ON. The display will then show a number beginning with "9".

3

Press MODE. Display will show CAL 0, with circular stability indicator . If not, turn OFF, then start over.

4

Press ZERO. The display shows CAL 1
Press MODE . The display shows CAL 2

5

Place the weight indicated in this table on the pan.	FW-150	100Kg
	FW-100	60Kg
	FW-60	40Kg
	FW-15	10Kg
	FW-10	6 Kg

6

Press ZERO after the circular stability indicator comes on. Display will show END.

7

Slide the calibration switch OFF, then turn OFF the scale. Calibration is complete.

Calibration with alternate weights is possible. Use these alternate weights by selecting a different CAL # at step 4

	CAL 1	CAL 2	CAL 3	CAL 4
FW150	150 Kg	100 Kg	300 lb	200 lb
FW100	100 Kg	60 Kg	200 lb	150 lb
FW60	60 Kg	40 Kg	120 lb	80 lb
FW15	15 Kg	10 Kg	30 lb	20 lb
FW 10	10 Kg	6 Kg	20 lb	15 lb

FX and FY -- Initialization / A & D

Under some conditions, a memory loss can occur. These units use a battery to support the volatile memory, which has operating parameters stored in it. A defective battery can be the cause of memory failure, but other causes are possible too.

It is recommended that only A&D authorized personnel use this procedure.

- 1
Turn the instrument ON, move the CAL switch to the OFF position.
- 2
While holding the RE-ZERO button down, slide the CAL switch to ON, then release RE-ZERO. < the display will show several Cs >.
- 3
Move the CAL switch back to the OFF position. <Display shows a number>
- 4
Move the CAL switch back to the ON position. The display will cycle through <model codes>. When the model code for the instrument you have shows, push the RE-ZERO button while the correct model code is showing. Display will show < Fs >.

If you press the wrong code, press ON/OFF, and start over.

FX40 = 1	FX2000 = 3	FX1200 = 7
FX200 = 2	FX4000 = 1	FY200 = -
FX300 = 4	FX3200 = 7	FX6000 = L
FX320 = 5	FY300 = 8	(the "L" for FX6000 is the bottom segment and the lower left segment)
FX400 = 0	FY3000 = 9	
FX3000 = 6	FY2000 = c	
- 5
Press SAMPLE and MODE simultaneously. < Display shows Ps >
- 6
Press SAMPLE and MODE simultaneously. < Display shows Es >
- 7
Move the CAL switch to the OFF position.
The initialization is complete, but span and linearity should be checked and adjusted as required. Also, the units of measure will have been reset, so that should be considered.

FX and FY -- Linearity & Calibration / A & D

LINEARITY

1. Remove all objects from weighing pan, instrument OFF.
2. Press AND HOLD the RE-ZERO button while momentarily pressing the ON/OFF, then release the RE-ZERO. < display lights up >
3. Press MODE. < Display shows C+numbers >
4. Slide the CAL switch to the ON position. < Display changes from "Lnr" to "tL" to "tH">
5. While the display is showing "Lnr", press RE-ZERO.
< "Lnr 0 displayed" >
6. Press RE-ZERO. < Display will show "Lnr 1" >
7. Place weight A on the pan. Refer to table #1

	A	B	
FX40	10g	20g	
FX/Y 200, 300	100g	200g	
FX320, 400	100g	200g	
FX1200	500g	500g	
FX2000	1 Kg	1 Kg	
FX/Y 3000 & 3200	1 Kg	2 Kg	Table #1
FX-4000	1 Kg	2 Kg	
FX-6000	1 Kg	5 Kg	

8. Wait for stability, then press RE-ZERO. < display will show "Lnr 2" >
9. Remove A, replace with B. Wait for stability, then press RE-ZERO.
< "Lnr F" will be displayed >
10. Place A and B on the pan. Wait for stability, then press RE-ZERO.
< display jumps between "Lnr", "tH", and "tL" >
11. Slide the CAL switch to the OFF position. Press ON/OFF twice.

SPAN

1. Empty the weighing pan, turn instrument ON.
2. Move the calibration switch to the ON position.
< display shows "CAL 0" >
3. Press RE-ZERO. < display will show "CAL F" >
4. Place weight B (from table #1) on the pan. Wait for stability, then press RE-ZERO.
5. Wait for the display to show " CAL End ", then return the calibration switch to the OFF position. Press ON/OFF twice.

GF Calibration / A&D

Permissible calibration weights:

model	factory setting	alternate via configuration
GF-200	200	100
GF-300	200	300
GF-1200	1000	500
GF-2000	2000	1000
GF-3000	2000	3000
GF-6000	5000	2000, 3000, 4000, 6000

1. Warmup 30 minutes minimum. No air drafts, pan empty.
2. Press and hold CAL key until CALout shows on the display, then release CAL.
- 3 The display should show CAL 0.
4. Press and release PRINT. The readout shows the required calibration weight.
5. Place the indicated weight on the pan, then press and release PRINT.
6. When the readout shows " End " , remove the weight.
7. Depending on user configuration, the instrument may show GLP, then output a calibration report via the RS-232 port.

GX internal weight calibration adjustment

The following instructions for adjusting the calibration of the internal weight on A&D GX series instruments is directly from A&D documentation. IES acknowledges A&D Engineering's cooperation, and thanks them for it.

GX/GF Maintenance manual

3. Fine adjustment of linearity (CAL 5Et) [Only GX]

The following explains about how the linearity around the internal mass is adjusted precisely.

(1) Warm up and preliminary load

Warm up the balance for at least one hour.

Apply a preliminary load by placing a load with the full scale value and remove it. Perform this pre-load three times.

(2) External mass calibration (CAL out)

Step 1. Display the data adjustment mode after getting into check mode shown on page 26.

Step 2. Press the key three times. is displayed.

Step 3. Press the key. The motor starts and adjust the internal mass position correctly.

Step 4. is displayed. Check the standard mass for calibration in table below.

Model	Standard masses
GX-200	200g
GX-400	400g
GX-600	500g
GX-2000	2kg
GX-4000	4kg
GX-6100/6000/8000	5kg

To change the calibration mass value, press the key and change the value as necessary using the following keys.

key: changes the blinking digit position.

key: changes the value of the blinking digit.

key: saves the data..

Step 5. With nothing placed on the pan, press the key. is displayed.

Step 6. After it stabilized, is displayed. (Example of the GX-600)

Step 7. Place the calibration mass specified in step 4 on the pan. Press the key. is displayed. (Example of the GX-600)

Step 8. After it stabilized, is displayed.

Step 9. Remove the mass.

continued next page

(3) Fine adjustment of linearity

Step 1. In the data adjustment mode `d-dSP`, press the `SAMPLE` key five times. `CALSET` is displayed.

Step 2. Press the `PRINT` key. The motor starts and adjusts the internal mass position correctly.

Step 3. The display changes in turn as follows:

`CC` → `<CC.` → `CC.` → `<CC.` → `End` → `LH`

Step 4. Proceed to the next step.

(4) Internal mass calibration (CAL in)

Step 1. In the data adjustment mode `d-dSP`, press the `SAMPLE` key four times. `CAL in` is displayed.

Step 2. Press the `PRINT` key. The motor starts and adjusts the internal mass position correctly.

Step 3. The display changes in turn as follows:

`CAL` → `<CAL.` → `CAL.` → `<CAL.` → `End`

FX Modes / A & D

Various units of measure are possible with the FX series. Individual units are made available to the user by **enabling** them. Thereafter, the user can **select** from those.

Enabling units of measure

- 1 Display OFF
 - 2 Press and hold MODE with pressing ON/OFF (display shows first unit of measure)
 - 3 Press SAMPLE/% if you wish to enable this unit, or press MODE again to progress to the next unit.
 - 4 When all of the desired units of measure have been enabled, press RE-ZERO.
 - 5 From this time onward, only the units which have just been enabled will be available for selection using the MODE key.
-

Selecting a unit of measure

- 1 Press MODE until the desired unit of measure is indicated.
-

Counting Mode

- 1 Press Mode until the display indicates "cnt".
- 2 Press RE-ZERO.
- 3 Press SAMPLE/%, display will show "10 cnt".
- 4 Place 10 items on the pan, then press SAMPLE/%.
- 5 The display will do one of two things:
 - a. It shows " 10 cnt ". If it does this, then it accepted the group of 10 items, and you are now in the counting mode.
 - b. It shows " 20 ", or some other number. The instrument is asking for a larger number of sample items. Add items to bring the total to the number indicated. When the instrument stops prompting the operator with larger numbers, it is in the counting mode.

HA Series Calibration / A&D

Introduction:

There are several aspects to calibrating the HF series. It will calibrate automatically when it senses a temperature change (self calibration) , or a calibration using the internal weight can be actuated by pressing the CAL button(**internal calibration**), or the instrument can be calibrated using an external weight(**external calibration**). Additionally, the coefficient of the internal weight can be adjusted to compensate for aging or other causes of calibration shift (**weight correction**).

Internal Calibration

Verify that the instrument is stable. Push the CAL button. Do not disturb the instrument in any way as it cycles through various indications on the digital display. When the digital display shows 0.0000 , then calibration is complete.

External Calibration

1. Verify that the weighing pan is empty and that the instrument is stable at zero.
2. Press and hold the CAL key, then press the PRINT key . The digital display will indicate the value of calibration weight which will be required. Release the CAL key .
3. Momentarily press the RE-ZERO key . As soon as CAL F shows on the display, place the previously indicated weight value on the pan, then close the glass doors .
4. When CAL END shows, remove the calibration weight

Weight Correction

1. Verify that the weighing pan is empty and that the instrument is stable at zero.
2. Press and hold the CAL key, then press the PRINT key. Press the PRINT key multiple times to increment the calibration value for the internal weight up or down in steps of .0001 gram, or press the MODE key to increment up or down in steps of .001 gram.

The digital display will indicate the value of calibration weight which will be required. Release the CAL key .

3. Momentarily press the RE-ZERO key . As soon as CAL F shows on the display, place the previously indicated weight value on the pan, then close the glass doors .
4. When CAL END shows, remove the calibration weight

HF Calibration & Linearity / A&D

Introduction: At any time during this procedure, if xxx shows on the display, then it is extremely import that the instrument not be exposed to vibration, air drafts, or other factors that would effect the stability. If the instrument shows "Error 1", then the instrument has detected enough instability that it will reject calibration .

Calibration

1. Start with the weighing pan empty and the instrument stable. Press and hold RE-ZERO . After CAL 0 shows on the display, release RE-ZERO .
2. Press RE-ZERO , CAL 0 will continue. Press RE-ZERO again, and the digital display will indicate the required calibration weight value. Place that weight on the pan.
3. Press RE-ZERO. After a pause, CAL END is displayed . Calibration is complete .Remove the weight.

Linearity

1. With display OFF, press and hold RE-ZERO and MODE simultaneously while momentarily pressing ON/OFF. Release only MODE, then press MODE twice quickly. Release all keys.
2. After showing software versions, the display shows all segments. Press RE-ZERO, the display will shows D-DSP.
3. Press MODE, the display goes to LNR. Press RE-ZERO, the display shows LNR 0. Press RE-ZERO again. After a delay, the display shows LNR 1.
4. Place the LNR 1 mass on the pan, then press RE-ZERO. After a delay, the display shows LNR 2.
5. Remove the LNR1 weight and replace it with LNR 2. Press RE-ZERO, the display shows LNR 3 after a delay.
6. Place both LNR1 and LNR2 on the pan simultaneously. Press RE-ZERO, the display shows LNR END after a delay. Remove the weights and press ON/OFF .
7. Re-establish calibration using the procedure above.

Weights for linearity - next page

Weights for HF linearity adjustment

HF model	LNR 1	LNR 2
200G	100	100
300/300G	100	200
320	100	200
400	200	200
1200G	500	500
2000G	1000	1000
3000/3000G	1000	2000
3200	1000	2000
4000	2000	2000
6000/6000G	2000	4000
8000	4000	4000

HR Span Calibration , Cornerload

Adjustment

Span

1. Warm up 4 hour, room temperature must be stable with 2 deg. 24/7. Nothing on the weighing pan.
2. Press and hold RE-ZERO until CAL 0 shows on the readout.
3. Press and release RE-ZERO. The display shows CAL ###. Place the ### weight on the pan at the center.
4. Press and release RE-ZERO.
5. Calibration finished, remove calibration weight.

Cornerload

1. Don't adjust cornerload needlessly. The tolerance is generally 2 graduations with half the weighing capacity as a test weight.
2. Zero the display with the weight at the center of the pan. Adjust the two adjusters as indicated by the diagram below. Each diagram show a symmetrical deviation and corresponding corrective adjustment. Make VERY small adjustments. An initial error of more than 20 graduations suggests a damaged cell, which needs repair rather than adjustment.

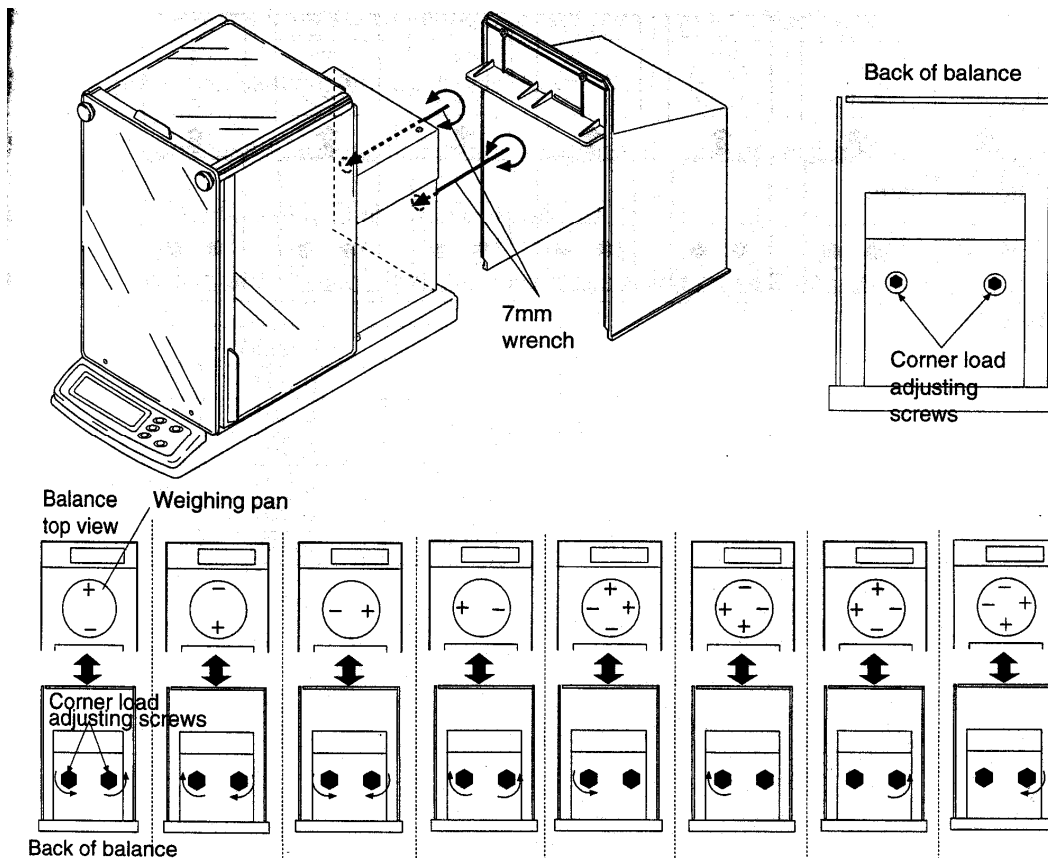

CAHN

Packing and Unpacking Cahn Microbalances

Cahn balances use tiny metallic wires to suspend the weighing pan. These wires are called "hangdowns", and they are quite delicate. During transportation, they are free to move (unless restrained), which can cause any of several problems. Rather than leave them free, restrain them as follows:

1) Cut one 8 inch length of mono-filament thread (fishing leader is great) for each hangdown. Tape one end of each filament onto the floor of the weighing chamber directly below each hangdown. Pass the free end through the loop of the hangdown, and secure this free end directly on top of the end previously taped. A large loop, which passes through the hangdown, now exists. Notice that the hangdown has not been placed under any tension, but rather it's movement is now limited gently by the big loop of fishing leader. Be sure to use fishing leader (sporting goods store), not sewing thread or string or wire.

2) When unpacking a microbalance which has been secured by the above method, take care not to pull on the hangdowns as the filament is removed. Electronic wire-cutters, or a finger-nail clipper, can be used to cut the filament. Be very careful that, as the tape is being peeled away, no excessive tension is applied to the hangdown.

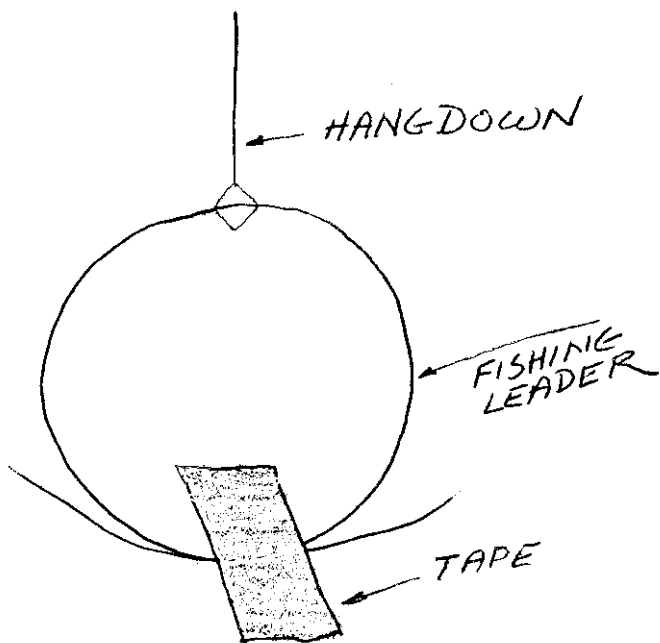

See general packaging instructions under "Packaging Lab Balances for Shipment" in the General Purpose Technical section of the Handbook.

21 23 25 Calibration - Cahn

The Cahn microbalances use a balanced beam. The balanced nature of the sensing mechanism makes it essential to have two pans on the instrument during weighing. The pans must be nearly equal in weight. Positions A and B are for the item being weighed, position C is for the counterbalancing pan

The various ranges of the instrument do not have separate calibrations. Each time the range is changed, the calibration needs to be performed again. Apparently, Cahn considered recalibration to be a part of each use of the instrument.

Moving the instrument will effect the linearity. The practical effect of this is that the instrument must always be used in the same place. There is no linearity adjustment, other than when the hangdowns are installed.

Calibration

1. Tare to zero.
2. Place the appropriate calibration weight on the weighing pan.
3. Adjust the CALIBRATION control until the readout indicates the correct weight.

28, 29 Calibration - Cahn

The Cahn microbalances use a balanced beam. The balanced nature of the sensing mechanism makes it essential to have two pans on the instrument during weighing. The pans must be nearly equal in weight. Positions A and B are for the item being weighed, position C is for the counterbalancing pan

The various ranges of the instrument do not have separate calibrations. Each time the range is changed, the calibration needs to be performed again. Apparently, Cahn considered recalibration to be a part of each use of the instrument.

Moving the instrument will effect the linearity. The practical effect of this is that the instrument must always be used in the same place. There is no linearity adjustment, other than when the hangdowns are installed.

Calibration: A hangdown position

1. Empty pan on both A and C positions .
2. Select RANGE , 200 for model 28
250 for model 29
3. Push TARE , display goes to zeros.
4. Place 200 mg on the A pan.
5. Push "CAL" , display shows calibration weight .

Calibration: B hangdown position

1. Empty pan on both B and C positions .
2. Select RANGE , 1000 for model 28
1250 for model 29
3. Push TARE , display goes to zeros.
4. Place 1000 mg on the B pan.
5. Push "CAL" , display shows calibration weight .

Model G -- Operating Instructions / Cahn

Using the model G involves three separate procedures:

- a. Zero
- b. Calibrate
- c. Measure

In each procedure, the beam is balanced before the adjustment is made. Calibration may be eliminated if RANGE and ZERO have not been adjusted.

ZERO

1) Select the desired RANGE using the switch on the top of the instrument. Place the FUNCTION SWITCH in the ZERO position. Place the appropriate pans in position.

2) With pans empty, view the lens in the weighing compartment while adjusting the BALANCE control. Adjust so that the hairlines form a single straight line. The beam is now balanced.

3) While pressing the RED BUTTON on top of the instrument, adjust the ZERO control for a centered indication on the METER.

CALIBRATE

1) Function SWITCH to CAL position.

Place a test weight equal to the full scale capacity on the appropriate pan. (example: 100 mg on the A pan). Use the BALANCE control to align the hairlines.

2) While pressing the RED BUTTON, adjust the CALIBRATE control for a centered indication on the METER.

MEASURE

1) Function switch to READ position.

Place the unknown weight on the pan. ("A" pan in this example)

Adjust the BALANCE control to align the hairlines.

2) While pressing the RED BUTTON, adjust the VERNIER for a centered indication on the METER. When so adjusted, release the RED BUTTON, and read the weight of the sample from the VERNIER dial.

The VERNIER divides the calibration value into 1,000 dial divisions.

The pans must be appropriate to the material being weighed; mismatched pans may make BALANCE impossible. Adjustment of COARSE ZERO may compensate some imbalance. Consult the model G operator's manual for further information.

TA Series – Calibration & Transportation Arrestment / Cahn

TA 450 Calibration:

1. Rezero
2. Place 50 gram weight on the pan.
3. Press the calibration button until “CALIBRATE” shows on the readout.
4. Press and release the CALIBRATE button

Transport Arrest

The TA series of instruments are built with either of two types of transportation lock down clamp. This note refers to the type which is on the **UNDERSIDE** of the instrument.

The instrument is arrested by engaging a screw to the measuring cell coil, which is not visible from the exterior. This screw also engages threads in the instrument case, and therefore locks the coil to the case, preventing it from moving.

There is **DANGER** in this system. The screw must not bind the threads in the case against the threads in the coil: it must engage both threads gently. The threaded screw has the ability to push against the coil with excessive force, and damage the instrument.

When installing the locking screw, follow these steps:

1 Place the instrument on it's side.

2 Engage a 5/8 inch 8-32 screw to the threads in the aluminum disk on the underside of the instrument. Use one hand to move the pan support on the top of the instrument back and forth, so that it is possible to feel when the screw touches the coil. Further rotate the screw, so that it engages the coil's threads. Only **LIGHT** finger-torque is required.

When removing the screw, only gentle torque is required.

4100 -- Operating Instructions / Cahn

Using the model 4100 involves two separate procedures:

- a. Calibrate
- b. Measure

In each procedure, the beam is balanced before the adjustment is made. Calibration may be eliminated if RANGE and ZERO have not been adjusted.

General:

Select the desired RANGE using the MILLIGRAM switch on the front panel.
Place the appropriate pans in position.

1)

With pans empty, view the NULL meter while adjusting the BALANCE control. Adjust so that the meter is centered.

3)

Adjust the ZERO control for all zeroes on the digital readout.

CALIBRATE

1)

Place a test weight equal to the full scale capacity on the appropriate pan.
(example: 200 mg on the A pan). Adjust BALANCE for a centered NULL meter.

2)

Adjust the CALIBRATE control for a reading of 200.00 on the digital readout.

MEASURE

1)

Place the unknown weight on the pan. ("A" pan in this example)
Adjust the BALANCE control to center the NULL meter.

2)

Read the weight of the sample from the digital readout.

The pans must be appropriate to the material being weighed; mismatched pans may make BALANCE impossible. Adjustment of COARSE ZERO may compensate some imbalance.
Consult the model 4100 operator's manual for further information.

Denver Instruments

A Series Analyticals -- Calibration / Denver Instruments

Calibration using the internal cal. weight

- 1
Press TARE, the display reads all zeroes.
- 2
Press AUTO/CAL , calibration proceeds automatically.

Calibration with an external calibration weight.

- 1
Press TARE, the display will read all zeroes.
- 2
Place 100 grams on the weighing pan.
- 3
Press AUTO/CAL, calibration proceeds automatically

Modification of internal weight correction value

- 0
Begin by determining the apparent error of the internal weight. For example, if after calibrating with the internal 100 gram weight, an accurate external 100 gram weight reads 100.0097, then the error is +97 counts. The last 3 digits of the error are the correction; 097 in this case.
- 1
Press AUTO/CAL, CAL shows on the display.
- 2
Select the weight to be corrected by repeatedly pushing the SET/UP key. When the desired weight shows, select it by pressing the ON/OFF button.
- 3
Repeatedly press the SELECT button. The sign on the display will change from + to - each time SELECT is pressed. Select either + or - by pushing ON/OFF when the desired sign is showing. Select + for minus errors and - for plus errors.
- 4
Repeatedly push SELECT to cycle through the most significant digit of the correction factor. For this example, this would be 0. Select the 0 by pressing ON/OFF.
- 5
Repeat step 4,, now selecting the next digit. For this example, press SELECT repeatedly until 9 shows, then press ON/OFF to select the 9.
- 6
Select the least significant digit by using the above procedure to select a 7.
- 7
This procedure concludes automatically when the last digit has been selected.

A200DS -- Linearity / Denver Instruments

	ACTION	Numeric Display	Alpha Display
1	Press SET UP		
		0.0000	SET UP
2	Press AUTO CAL		
		0.0000	INITIALZ, GRAM
3	Press SELECT		
		0.0000	INIT, then GRAM
4	Press SELECT		
		0.0000	LIN, then GRAM
5	Press ON/OFF, wait for stability		
		6 digit #	LIN1, then GRAM
6	Press ON/OFF, wait for stability		
		6 digit #	LIN2, then GRAM
7	Apply first 100 gram weight, wait for stability		
		7 digit #	GRAM
8	Press ON/OFF, wait for stability		
		7 digit #	LIN3, then GRAM
9	Remove first 100 gram weight, replace with second 100 gram weight Wait for stability		
		7 digit #	GRAM
10	Press ON/OFF		
		7 digit #	LIN4, then GRAM
11	Add the first weight to the pan		
		7 digit #	GRAM
12	Wait for stability, then press ON/OFF		
		7 digit #	L#####, GRAM
13	Wait for stability		
14	Press AUTOCAL to calibrate		

DI Series -- Linearity Correction Procedure / Denver Instruments

Software Revision 2.21 and Higher ONLY. To check the software version, press and hold buttons #1 and #3 at the same time. The display will list the model, serial number, and software version of your unit. If your software version is below 2.1, please contact Denver Instrument Company. If your software version is 2.21 or higher, please continue.

Tools: Two weights (any two weights as long as the combined weight does not exceed the capacity of the balance), needle nose pliers, tweezers, and Xacto knife.

1. Remove weighing pan and disconnect both the power supply and the communication cable from the front panel.
2. Cut silver seal from the E-Prom cover on the underneath side of the front panel. USE XACTO KNIFE TO CUT SEAL. Cover opens from the same end where the seal is located.

3. Once the cover is off, locate the 4 pin RJ11 connector. This is the output for the communication cable from the front panel to the weighing cell. The board you will have five (5) pins to the right of the connector, three (3) pins to the left of the connector, or no pins at all.

For five (5) pins:

Note that the five pins are numbered 1-5 with pin 5 in the middle. Locate the jumper between pin 2 and pin 5. Using needle nose pliers remove the jumper from pins 2 and 5. Reconnect between pins 4 and 5. Proceed to #4.

For Three (3) pins and a blue jumper:

Remove jumper from the middle pin and the front pin. Reconnect the jumper to the middle pin and the pin at the rear end. Proceed to #4.

For three (3) pins without jumper:

Short the middle pin and the rear pin. Proceed to #4. Continue to short pins until step #7.

For three holes without pins:

Use tweezers to short square hole and middle hole. Reconnect communication cable and power supply with tweezers in place. Proceed to #4. Continue to short pins until step #7.

4. Plug communication cable back into both the front panel and the weighing cell. Make sure the communication cable is plugged into the front panel and the weigh cell BEFORE connecting power. If power is applied to the balance prior to the communication cable, you will have an IO ERROR. Please unplug and reconnect.
5. Press MENU key once. MENU 1 of 3 will appear.
6. Press key #4 and #6 **at the same time**. "SM SET UP" will appear at the top of the screen. If the CHECK WEIGHING MENU appears, you did not press both keys at the same time. Exit CHECK WEIGHING by pressing the ENTER key.
7. When key #4 and #6 are pressed at the same time, the following will appear:
 - "SM SET UP"
 - 0. SM ZERO
 - 1. SM SCALE

DI Series -- Linearity Correction Procedure (continued p. 2) / Denver Instruments

7. Continued:

2. SM LINEARITY
3. SM SENSOR RATIO
4. MS TEMPERATURE
5. SM DISPLAY COEFFICIENTS

8. Press key #2 (SM LINEARITY). The screen will display "LINEARITY MENU":

```

CYCLE:   NO WEIGHT
AVERAGES: 0
RAW WEIGHT:  XXXXXXXXX
SCALED WEIGHT :  X.XXXXX

```

9. Under the "LINEARITY MENU", "CYCLE" will display "NO WEIGHT" and "AVERAGES" will display "0". Press the ENTER key. Averages will count between 0 and 19 and then return to 0.

10. "CYCLE" will now display "WEIGHT #1". Place one of your two weights on the pan. Wait ten (10) seconds and press the ENTER key.

11. "AVERAGES" will count between 0 and 19 and return to 0.

12. "CYCLE" will now display "WEIGHT #2". Remove first weight and place second weight on the pan. Wait ten (10) seconds and press the ENTER key.

13. "AVERAGES" will count between 0 and 19 and return to 0.

14. "CYCLE" will now display "BOTH WEIGHTS". Leave the second weight on the pan and add the first weight. Wait ten seconds and press the ENTER key.

15. "AVERAGES" WILL COUNT TO 19 and stop. Menu: Coefficient = XXXXXX. Wait ten (10) seconds and press the ENTER key. You are now finished with the linearity adjustment. Remove weights and press the ZERO key until the balance displays zero: (0.0g, 0.00g, 0.000g, 0.0000g).

LINEARITY CHECK:

A. Place first weight on pan and record the value. Remove weight and place second weight on the pan and press the ZERO key until the balance displays zero: (0.0g, 0.00g, 0.000g, 0.0000g).

B. Leave second weight on pan, place 1st weight back on pan, and record the value. Compare this value with the first recorded value. A two count variation is allowed between the 1st and 2nd value.

16. The balance should be CALIBRATED at this time. Press MENU key once. Menu #1 of #3 will appear. Press the #1 key (CALIBRATE). Place the xxx weight on the platform. There are four (4) preset weights the balance will automatically accept for calibration. However, after this procedure, it is likely that you will have to enter the calibration manually. To enter calibration manually, place the calibration weight on the pan. After the balance stabilizes, the display will read "ENTER CAL WEIGHT IN GRAMS". Enter the numerical value of your calibration weight followed by the ENTER key. If the balance DOES NOT calibrate, repeat steps 5 through 15.

DI Series -- Linearity Correction Procedure (continued p. 3) / Denver Instruments

IES Corporation, 2324 SE 11th Ave, Portland, OR 97214

PHONE: 1-800-541-0852/1-503-230-0646 FAX: 1-503-235-2535 e-mail: office@iescorp.com

17. Once the balance is calibrated, remove the pan, unplug power and communication cable from front panel. CHANGE BLUE JUMPER back to ORIGINAL POSITION. See Step #3. Replace E-Prom cover, reconnect communication cable and power supply.

TL, DTL, 7xxx, 8xxx ,M, MX - how to tell what's what

(These are older instrument - from the 1980s) . Not all instruments of every model of DIC instrument are identical. DIC has changed construction methods within some model names. So individual examples of some models will be different in internal construction, even though the external appearance is similar.

IES has found that certain characteristics of individual instruments are representative, and attention to them will assist in calibration.

A - Instruments which have 4 pots along the rear, EQUAL spacing between them.
(View from rear)

right-most	FINE calibration
next	COARSE calibration
next	Linearity
left -most	temperature compensation (don't touch)

B - Instruments with 4 pots UNEQUALLY spaced
(Rear view)

right - most	Linearity
next	Temp. Comp.
next	Coarse Cal.
left-most	Fine Cal.

Possible Models: 7xxx, 8xxx, TL, DTL, M, MX

C - Internal construction: Two parallel boards, 1 analog above, one digital below.
(View right side of instrument)

Rear-most	linearity
next	calibration
Front	reference (don't adjust)

Possible models: DTL, TL, 7xxx

D - Large pot on rear panel, plus 3 normal size adjustment pots
(Rear view)

Right most	large calibration knob/pot
next	blank out
next	coarse cal
left most	temp comp

Possible models: 300, XM300, 50

If the unit seems to be functional, but shows obvious over-range or calibration errors, the non-volatile RAM may have become de-programmed. It can be initialized with the following procedure.

- 1 Power OFF
- 2 Hold down MODE and AUTO CAL
- 3 Power ON
- 4 As soon as INIT appears on the display, let off MODE and AUTO CAL
- 5 Operate the MODE switch to select the desired MODE
- 6 TARE to reset display to 0.00

Calibration

It seems that not all TL type units are the same, so the calibration instructions are different for each. If the unit has a AUTO CAL button, then place a calibration weight on the pan (example: TL410 uses 400 gram weight) , then push AUTO CAL. The unit calibrates and returns to normal operation.

If the unit does not have an AUTO CAL button on the front panel, then it's an older type, and calibrates using potentiometers. That's detailed in the article named " DIC - Many Models ", elsewhere in the IES handbook.

TR / TL (new) / TC Linearity

1. Remove any weight on the balance and press the “Zero” key to re-zero the balance.
2. Press “Mode” key. Display reads “MODE....CALIBRATE”.
3. Press “Next” key until “SYSTEM” appears, then press “Enter”.
4. Press “Next” key until “SECURITY” appears, then press “Enter”.
(NOTE! If you have previously been in the security mode, and have not unplugged the balance, the next steps, 6-10 will be unnecessary.)
5. “SUPR USR” appears, as well as some asterisks, the first of which will be flashing.
6. Press the ‘down’ arrow key to advance the first asterisk to “D”.
7. Press the ‘right’ arrow key to move to the next digit.
8. Press the ‘down’ arrow key to advance the second asterisk to “I”.
9. Press the ‘right’ arrow key to move to the next digit.
10. Press the ‘down’ arrow key to advance the third asterisk to “C”.
11. Press “Enter”. “MAINT....SCALE” appears.
12. Press “Select” key until “LINEARITY” appears.
13. Press “Enter”. “CALC LIN....GET A POINT” appears.
14. Press “Select” until “CLEAR DATA” appears.
15. Press “Enter”. “CALC LIN....COMPUTE” appears.
16. Press “Select” until “GET A POINT” appears.
17. Press “Enter”. “ADD WGT 1” appears.
18. Place 1st weight, according to attached chart for the model, on the pan.
19. Press “Enter”. Unit will display “STABILIZ”, counting down, and then “AVERAGE”, counting down, then “LIN WGT”, and some numbers.
20. Remove weight, and press “Enter” twice.
21. Unit will now display “ADD WGT 2”.
22. Repeat this process until all of the weights indicated in the chart have been utilized.
23. Press “Enter”.
24. Press “Select” until “COMPUTE” appears.
25. Press “Enter”. Unit should now display “COMPUTE....COMPUTED”.
26. Press “Zero” button to go back to weigh mode, and check to see if linearity is set.
27. To reset Security, unplug balance, and plug back in.

Continued - next page

Denver TR / TL / TC , continued**Linearity Weight Settings**

Model	1	2	3	4	5	6	7	8
64	10	20	30	40	50	60		
104	10	20	50	60	70	90	100	
204	10	20	30	50	100	150	200	
203	10	20	30	50	100	150	200	
403	10	20	50	100	200	300	400	
402	10	20	50	100	200	300	400	
603D	50	100	200	300	400	500	600	
602	50	100	200	300	400	500	600	
2102	200	400	600	800	1000	1500	2000	
2101	200	400	600	800	1000	1500	2000	
4102D	200	500	1000	1500	2000	3000	4000	
4102	200	500	1000	1500	2000	3000	4000	
4101	200	500	1000	1500	2000	3000	4000	
6101	500	1000	2000	3000	4000	5000	6000	
8102D	1000	2000	3000	4000	5000	6000	7000	8000
8101	1000	2000	3000	4000	5000	6000	7000	8000
12001	1000	2000	3000	4000	6000	8000	10000	12000

TL Calibration and Password (new TL series) – Denver Instrument

Denver Instrument Company (DIC) made a series of instruments with “TL” prefix years ago. You can tell the old TL from the new TL because the new TL’s model number implies the capacity and resolution. For example, TL403 is 400 gram capacity and 3 decimal places to the right of the decimal. TL4102 is 4100 gram capacity and 2 places to the right of the decimal. The old models didn’t have that naming system, so they would have a model number like TL2500, for example. *If the last digit of the model number is 1, 2, 3, or 4, then it is a **new** TL type.* This instruction only refers to the new type TL.

The instrument will calibrate using standard mass values (DIC calls this “External”), or a mass value that you enter via the keypad (DIC calls this “Manual”). IES strongly recommends that you not use the “Manual” calibration unless you have the DIC User Manual and have time to learn those instructions and correct errors. The instructions below are for “External” calibration. The chart below shows the standard mass values.

model	weight																	
	20	30	50	60	10	20	30	40	50	60	80	1	2	4	5	6	8	12
					0	0	0	0	0	0	0	K	K	K	K	K	K	K
64	x	x	x	x														
104	x	x	x	x	x													
203			x	x	x	x												
204			x	x	x	x												
402					x	x	x	x										
403					x	x	x	x										
602					x	x	x	x	x	x								
603D				x	x	x	x	x	x	x								
2101								x	x	x		x	x					
2102								x	x	x		x	x					
4101										x		x	x	x				
4102										x		x	x	x				
4102D								x	x	x		x	x	x				
6101													x	x	x	x		
8101													x	x	x	x	x	
8102D											x	x	x	x	x	x	x	
12001														x	x	x	x	x

The three round buttons below the readout are called “softkeys”. Their function is variable depending on what operation is being performed. The current function is indicated on the readout immediately above each softkey. At any time, press “ZERO” to exit menus and return to normal operation.

continued on next pages

Calibration with external standard value mass:

Action	Result
Press MODE softkey	Display shows “MODE” , with “CALIBRATE” shown in the lower left
Confirm selection on “CALIBRATE” function by pressing ENTER softkey	Display shows CAL, with “External” shown in the lower left
Confirm selection of “External” by pressing ENTER softkey	instrument waits for calibration weigh from table above
Place calibration weight on the pan	Instrument completes calibration, and returns to weighing mode automatically

If you are prompted for a password, use D I C .

Note: When you press MODE, you start the menu system. It so happens that CALIBRATION is the first function, so there is no need to scroll through the menu to get to CALIBRATION. But the MODE button is the entry path to all other configuration aspects in the menu system.

For further information on configuration or calibration, see the full TL User Manual at <http://denverinstrumentusa.com> . Choose the “downloads” option at the top of the page.

TR Calibration and Password – Denver**Instrument**

The instrument will calibrate using standard mass values as indicated in the table below.

model	weight																		
	20	30	50	60	100	200	300	400	500	600	800	1K	2K	4K	5K	6K	8K	12K	
64	x	x	x	x															
104	x	x	x	x	x														
203			x	x	x	x													
204			x	x	x	x													
402					x	x	x	x											
403					x	x	x	x											
602					x	x	x	x	x	x									
603D				x	x	x	x	x	x	x									
2101								x	x	x		x	x						
2102								x	x	x		x	x						
4101										x		x	x	x					
4102										x		x	x	x					
4102D								x	x	x		x	x	x					
6101													x	x	x	x			
8101													x	x	x	x	x		
8102D											x	x	x	x	x	x	x		
12001													x	x	x	x	x		x

The three round buttons below the readout are called “softkeys”. Their function is variable depending on what operation is being performed. The current function is indicated on the readout immediately above each softkey. At any time, press “ZERO” to exit menus and return to normal operation.

Calibration with external standard value mass:

Action	Result
Press MODE softkey	Display shows “MODE” , with “CALIBRATE” shown in the lower left
Confirm selection on “CALIBRATE” function by pressing ENTER softkey	Display shows 0.00, with “ADD WEIGHT ” shown in the lower left
Place calibration weight on the pan	Instrument completes calibration, and returns to weighing mode automatically

Unlike the TL series, the TR does not allow calibration to values other than the nominal values shown in the table.

If you are prompted for a password, use D I C .

For further information on configuration or calibration, see the full TR User Manual at <http://denverinstrumentusa.com> . Choose the “downloads” option at the top of the page.

XA series -- Calibration and Linearity / Denver Instruments

Special Note: Not all XA instruments have the ability to adjust linearity and calibration under software control. When the instrument powers up, the software revision will be shown. Those with revision H or latter will have software adjustment capability.

Calibrate

Press "AUTOCAL", the internal mechanism uses the internal weight to calibrate.

Linearity :

Two weights are required for linearity adjustment on each available range

	weight "A"	weight "B"
30 gram range	10	20
100	50	50
200 or 250	100	100

Adjustment

Action	Display
No weight on pan, press TARE bar	0.0000
Press SET UP, then DISPLAY LOCK	LIN 1 then Stable Number
Press DISPLAY LOCK	LIN 2
Put "A" on the pan as soon as "LIN2" appears	Stable Number
Press DISPLAY LOCK	LIN 3
Remove "A" as soon as LIN 3 appears, replace with "B"	Stable Number
Press DISPLAY LOCK	LIN 4
Add "A" to "B"	Stable Number
Press DISPLAY LOCK	L # # Stable Number
Remove all weights; unit reverts to normal weighing mode	

XA series -- Calibration and Linearity (continued) / Denver Instruments

Calibration of Internal Weight

Opinion of IES: The procedure outlined in the DIC service manual is hard to understand. We have found that the most productive way to re-calibrate the internal weight is to start by adjusting the "offset" stored in the instrument memory to zero, then adjust iteratively until calibration is correct. You'll need to record settings and corresponding deviations manually. There is a separate offset for the coarse and fine ranges on dual range types.

Action

1. Press AUTOCAL, then press SETUP 4 times to select CAL 125.
2. Press MEMORY ENTER to verify your choice and begin offset modification.
3. Select plus or minus sign using the RECALL key [start with +]
4. Press RECALL to select 0 or 1 for the first digit (most significant) [start with 0]
5. Press MEMORY ENTER to enter.
6. Press RECALL to move to next digit, and select either 0 or 1 [again, 0 for starters]
7. Press MEMORY ENTER
8. Use RECALL and MEMORY ENTER to set all digits
9. After all digits have been set, press AUTOCAL to calibrate with internal weight and the new offset.
10. Compare readings of external known standard with the actual weight, compute and record difference.
11. Change offset with steps 1 through 8. Then recalibrate as at step 9.
12. Use recorded offsets and measured deviations to converge on the best offset.

XD/AC -- Linearity / Denver Instruments

This procedure adjusts the XD linearity. Like many DIC products, the weight values at specific steps in the linearity correction are best determined by trial and error. Typical values are no-load, 1/3 capacity, 1/2 capacity, 2/3 capacity, 3/4 capacity, and full capacity. Some instruments may require that the same weight be used twice. Some instruments won't use no-load at LIN 1; instead a weight will be required. There seems to be no method to the madness.

Action	Display Response
Press "SET UP" button.	
Press "AUTO CAL" button.	
Press "up arrow/down arrow" button. repeatedly until "LIN " is displayed.	LIN.
Press "ON/OFF" button.	LIN 1
verify no load on pan Press "ON/OFF" button.	LIN 2
place 1/3 capacity on pan Press "ON/OFF" button.	LIN3
place 2/3 capacity on pan Press "ON/OFF" button.	LIN 4
place full capacity on pan Press "ON/OFF" button.	LIN #####

Linearity is complete.
Re calibrate after adjusting linearity.

Re calibrate:

- 1
Calibration weight on the pan.

- 2
Press "AUTO CAL" button.

XD-100A and Dual Display Analyticals -- Linearity and Calibration / Denver Instruments

Ideally, you should have two ASTM class 1 50 gram weights for this procedure. You can use lesser weights and still get linearity correct (balance software will account for errors in the weights), but you still need an accurate 100 gram weight at the conclusion.

Linearity and Calibration

	Action	Display result
1	Press Set UP key	SET UP
2	Press AUTO CAL	INITIALZ
3	Press <dual arrow> key	INIT
4	Press <dual arrow> key again	LIN
5	Press ON/OFF	LIN1
6	Wait for stability, then press ON/OFF again	LIN2
7	Place 1/2 capacity weight on the pan, wait for a stable reading, then press ON/OFF again	LIN3
8	Remove the first weight, replace it with the second. When the display is stable, press ON/OFF.	LIN4
9	Place both weights on the pan. When stable, press ON/OFF	L###
10	Remove the weights, then press TARE.	
11	Both weights on the pan. Press AUTO CAL	CAL 100
	The balance is calibrated and linear	

XL/AL Series -- Calibration and Linearity /**Fisher/Denver Instrument**

The model number implies the capacity and preferred calibration weight for the unit. For example, and XL-400D should calibrate with a 400 gram weight. Under some circumstances, you may want to calibrate at some point other than full capacity. The instrument's microprocessor has been programmed to determine what the calibration weight is, and calibrate to that value. The chart below indicates the choices:

Model	Possible Calibration Weights
XL-300	100, 200, 300
XL-400	30, 200, 300, 400
XL-500	100, 200, 400, 500
XL-1800	500, 1000, 1500, 1800
XL-5K	1000, 2000, 4000, 5000

To calibrate, proceed as follows:

Action	Display Indication
Press TARE	
	0.00 g
Place cal. weight on pan	
	400.21 g (example)
Press AUTO CAL	
	400.00 g

AL Series with – 44 after model number

This series has a ZERO button and two hidden buttons (CAL, PRINT) above the zero. The CAL is the left button and PRINT On the right.

To calibrate: Press the hidden CAL button. Place calibration weight on pan (use chart above).

If the balance will not calibrate, Remove pan and top chassis. There is a jumper on the circuit board Under the keypad. The jumper should be across BOTH pins.

Linearity

Probably, you will need two test weights to do linearity. The first (A) will be 1/3 of capacity, the second (B) will be 2/3 of capacity. Since DIC isn't always utterly consistent, you may need to experiment with linearity weights.

Action	Displayed Result
Press TARE and CAL simultaneously	
	SET UP
Press PRINT	
	LIN 1
Press PRINT	
	LIN 2
Place weight A on the pan, wait for stability	
Press PRINT	
	LIN 3
Remove weight "A", replace with "B"	
Press PRINT	
	LIN 4
Place "A" on with "B"	
Press PRINT	
	L# # # #
Remove weights, then calibrate	

XP Calibration

Within the XP series, there are two general types of instruments. These are distinguished by whether they have four or six buttons on the front panel. Within either of those groups, there are several models. Be sure to use instructions for the appropriate group.

Calibration

Four button (-0- , * , ↓ , I/O)

1. With pan empty , rezero by pressing -0- .
2. Press the * button for 3 seconds. The display will show "Unit".
3. Press and hold the * button until "CAL" show on the display .
4. Press the ↓ button. The display will show the required calibration weight .
Place that weight on the pan .
5. When the display flashes, the calibration has been accepted. Calibration complete.

Six button (U , * , -O- , F , n / % , →T)

1. While pressing the U button, power up the instrument .
Release the U button when CAL shows on the display .
2. Press the T button. A number between 2700 and 3300 should show. If not in that range, adjust the trimmer that is under the cover on the front left side. The trimmer has a "stopper" that must be removed prior to adjustment, and replaced afterwards .
3. Press the -O- button, the display will rezero. Place the calibration weight on the pan (weight from table below).
4. Press and hold the n / % button until the desired weight shows on the display, then release the button.
Press n / % once more to select that weight .
5. Remove the test weight, then press -O- .

Weight Choices - 6 button models

XP-300	XP-600	XP-1500	XP-3000
100	200	500	1000
200	400	1000	2000
300	600	1500	3000

XT and Z Series -- Calibration / Denver Instruments

HELP

DIC has installed a help menu system IN THE ROM of the instrument. If you have questions about particular key functions on the panel, just push the HELP button. The display is alpha-numeric, and will instruct you on how to get the information on the particular function you are interested in. Try it.

CALIBRATE

The instrument microprocessor will detect and distinguish between calibration weights in even fractions of the over-all range. (Example: Z12000 will correctly identify 4000, 5000, 8000 or 10000 gram weight, Z400 will identify 100,200,300 or 400 gram weight) . Place the calibration weight on the pan, then push AUTOCAL. Calibration is complete.

Set-Limit function

As outlined above, the HELP key will instruct you on how to use the set limit function. But here it is on paper.....

1.
Press "LOW LIMIT" button.
2.
Key in lower limit weight using number keys. Do not insert a decimal point, the instrument does that automatically.
3.
Press ENTER.
- 4
Press HIGH LIMIT. Key in upper weight limit using number keys.
- 5
Press ENTER.
- 6
Press FILL (display shows FILL ON)

Now, the buzzer will beep whenever the applied weight is out of range. The instrument toggles between having the buzzer enabled or not each time the FILL button is pressed.

XT and Z Series -- Linearity & Calibration / Denver Instruments

*** Linearity ***

Preface: There are several different XT instruments; different in construction but all called XT. Some XT's have a linearity pot, located on the rear panel. If there are two pots, the top one is linearity. If there is one pot, then it is NOT linearity, and the following instructions apply:

1

TARE

2

Press "SET UP" , then the "." key. LIN1 will be displayed.

3

Wait for a stable number ("g" indicated), then press "."
LIN2 will be displayed.

4

Place a weight of 1/2 capacity on the pan, wait for stability.

5

Press "." Display will show LIN3.

6

Remove first weight and replace with a second one of equal weight.

7

Press "." LIN4 will be displayed. And the first weight to the one currently on the pan.

8

Wait for stability, then press "."

9

The instrument will return to the normal mode after reporting a linearity number via the display.

(Continued next page)

XT Series -- Linearity and Calibration (continued) / Denver Instruments

*** Calibrate ***

1

Place a weight near the capacity of the instrument on the pan. (example: XT7K - 5 Kg calibration weight) The instrument will read erroneously, since it is not calibrated.

2

Push "AUTOCAL" The instrument will read 5000.0 Calibration is now complete. Note the instrument's microprocessor has detected that the calibration weight is near 5000, and therefore calibrates the instrument to read exactly 5000. The microprocessor can tell the difference between weights 4 Kg, 5 Kg, 6Kg, 7Kg.

8301 -- Instructions For Operating In Counting Mode / Denver Instruments

- 1) Have a sample of the item to be counted on hand.
- 2) Plug in balance, turn on, let warm up.
- 3) Push "Func" button repeatedly until "U" appears.
- 4) Push "TARE" continuously until P-CAL-1 appears.
- 5) Place the sample item on the pan.
- 6) Instrument is now in the counting mode.
- 7) If it is desired to make the reference count a number other than one (step 4) , such as 10 or 50, then have that group of parts available at step 4. At step 4, hold "TARE" until P-CAL-x reaches the desired number.

METTLER

AC and PC -- Calibration and Linearity / Mettler

The PC group (includes AC-88 and AC-100) encompass a wide range of capacities and resolution, from 80 grams to 24 Kg.

The top loader types, (with chassis about 11" deep by 7" wide by 4" tall) have the circuit board on the right side of the instrument, running from front to back. There are four pots on that main board. **The calibration** pot is mounted on the main board, but is accessible through a hole near the **right rear upper corner**. The other three pots on the board are only accessible after removing the instrument top cover (large screw under the pan). Of those three pots, the front one is linearity, the other two are temperature compensation. DON'T adjust the temperature compensation unless you KNOW that the rest of the instrument is in good condition, AND you know how to adjust temp. comp. in general. Definitely DO NOT try to "fix" instruments which are drifty by adjusting drift with these pots!

The larger capacity types have a larger chassis (about 14"x11"x5"). The circuitry is similar, but mounted differently. R10 is the **calibration pot**, and is accessible from the exterior on the **right hand side**. The other three pots are mounted near the front right corner on the main board, R13 is linearity and is the front-most in the group of pots. Don't adjust the other pots!

Mettler used a "trim resistor" on all the PC instruments, which is effectively a coarse calibration trim. After the trim resistor is correctly selected, the instrument can be calibrated with the calibration pot. The trim resistor is R11 on the toploaders, R3 on the high-capacity types. Technicians should be suspicious of any instrument that needs a new trim resistor, since it shouldn't need replacement except when critical circuit board repairs are made. In any case, use only 50ppm TC precision resistors .

The AC/PC series has a group of 5 slide switches located towards the front of the main circuit board. The slide switches are set differently for different models. The chart below shows switch settings for specific models. When microprocessor 41375 is installed AND the switch settings are in a position designated for a specific model, that model number will be displayed on the readout when the instrument is turned ON. If the switches are not set at a designated model, the readout will show all 8s at turn on. If uP 41109 is installed, no model number will be displayed. The following data recorded for board ME41384 /ES41383 with ME41375 microprocessor. Other boards or other microprocessors will function differently.

Switches are numbered 1 to 5 from bottom to top. On=Rear , Off=Forward

switch	model
12345	
00000	AC100
00001	PC400C
00010	PC180
00011	PC440
00100	PC2000
00101	PC4400
00110	PC8000
00111	PC16

All other switch combinations - No model designated.

AE-160/163 -- Calibration / Mettler

1)

Plug in the balance, turn it on, and let it warm up for at least 5 minutes. Level the balance. The balance must remain stable throughout the entire calibration sequence. Instability is indicated by a decimal point in the left bottom corner of the display.

2)

Be sure the calibration lever (right side of instrument, on the bottom), is in the forward position.

3)

Push the "TARE" bar until "CAL ---- " appears on the display. When it does, let up the "TARE" bar immediately.

4)

When the flashing number "100" appears after the "CAL", push the calibration lever to the rear position. Leave it in the rear position until a flashing "0" appears, then move it back to the forward position.

5)

When "0.0000" appears, the calibration sequence is complete.

Tolerances: AE160	Cornerload	50 g test weight	/ .0002 g deviation
	Linearity	.0002 g deviation	

AE -- Linearity / Mettler

Hazardous electric circuits will be accessible during this procedure. This procedure is for qualified electronic technicians only.

Mettler specifies two 80 gram weights for linearity adjustment. However, it is possible to use, for example, a 50 gram and a 100 gram weight. The internal calibration weight can serve as the 100 gram, so only one 50 gram external weight is then required. No matter what weights are used for adjustment, two 80 gram weights are required to conform with the Mettler test specification.

A general discussion of linearity correction and adjustment exists in the "General" section of the IES Handbook. Adjustment of linearity is done directly at the cell. Access as follows:

a) Unplug the instrument. Remove the draft shield by removing the large bolt near the front left corner on the underside of the chassis. This allows the draft shield to move toward the rear about 1/4th inch, then it can be lifted up and away.

b) Locate the ribbon cable on the front of the aluminum shroud around the cell. Unplug the ribbon cable at the electronic chassis. Remove the two screws (recessed) which secure the chassis to the top of the shroud. Place the electronic chassis immediately to the right of the instrument, towards the rear, and re-secure the ribbon cable connector. Plug in and turn ON.

c) You will need draft protection shields for both the weighing pan and the exposed top of the cell. Otherwise, unstable readings will make adjustment impossible. Verify stability to within 1 digit.

d) Locate the two holes in the aluminum bar which straddles the rear of the cell, at the top. Notice that a long Phillips screwdriver can pass through these holes to engage Phillips screws directly below. These screws adjust the vertical height of the null indicator, and therefore adjust linearity.

e) Make a chart to record the existing linearity errors. Using an external 50 gram weight, adjust linearity so that the 50 gram weight reads the same whether or not preloaded with the internal 100 gram. There is no need to make the 50 gram weight actually read 50.0000 at this point; only a match between preloaded and not is needed. Make very small adjustments--just a fraction of a rotation. If the reading without preload is larger than the reading with preload, the screws will need to go counterclockwise. Turn both Philips screws equally in each adjustment. Independent adjustment of the .01 mg sensitivity range is not possible.

f) Reassemble all above. Calibrate using internal calibration weight.

	Coarse	Coarse	Fine	Fine
Model	Tolerance	Weights	Tolerance	Weights
AE-50	.1 mg	2 x 20g		
AE-100	.2 mg	2 x 50g		
AE-160	.2 mg	2 x 80g		
AE-163	.2 mg	2 x 80g	.03 mg	2 x 10g
AE-200	.3 mg	2 x 100g		
AE-240	.3 mg	2 x 100g	.04 mg	2 x 20g

AE Display board exchange

The AE series have display boards that are easy to exchange. This is useful because the board itself is prone to several problems, notably a dimming of the displayed numbers. A replacement display board returns the unit to service with bright , clear numbers that will last for many more years.

To exchange the display, proceed as follows:

1. Unplug the instrument
2. Slide the glass doors open and remove the weighing pan.
3. Move the instrument on the work bench so that the front 3 inches (75mm) of the unit overhangs the edge of the bench. This allows the technician to see two screws on the underside of the instrument, near the front, which secure the cover over the display board. Remove those two screws.
CAUTION: Do not tilt the whole instrument backwards, in order to make removing the screws easier. Doing so may dislodge the internal calibration weight, thus making calibration impossible or normal operation unstable.
4. With the screws removed. the metal cover over the display will be loose. Remove it.
5. The display board is visible with the cover removed. Notice that two screws secure the circuit board to the chassis. Remove those two screws, and the aluminum plate that is also secured by those screws.
6. Notice the ribbon cable that attaches to the board , towards the right rear of that board. Carefully pull on the connector plug (not on the cable itself) so that the plug separates from the board. The old board may now be removed, and replaced with the new one . Use great care in plugging and unplugging the cable.
7. Secure the new board with the aluminum plate and screws that were removed at step 5.
8. Replace the cover (removed at step 4) , and secure with screws (removed at step 3).

Mettler AE display board - tare bar replacement

IES advises you strongly not to attempt removing the tare bar from the display board. The likely result would be that the tare bar is damaged, and the instrument becomes useless.

AG -- Calibration and Menu / Mettler

Mettler's AG style analytical balance calibrates from the front panel. There is no linearity adjustment without the special service software and circuit board, which Mettler-Toledo doesn't sell.

Calibration (SPAN)

1

Allow the unit to warm up. Analytical balances need to operate continuously, and in an environment that is temperature regulated continuously.

2

Push and hold the **1/10d** button until **CAL Int** shows on the readout, then release the button.

3

The display will sequence through a series of displays, including dashes, numbers, all zeros, and a **CAL done** indication. It will return to normal operation automatically.

Parameter Adjustments

1

The unit has a pull-up menu card attached to the rear of the unit. Just pull up the tab on the top-rear edge.

AK, PK, and HK -- Calibration / Mettler

This was Mettler's first instrument to use software calibration. Accordingly, it is somewhat less "user-friendly" than their latter versions. If the instrument has any external devices connected (printer, etc.), then you MUST disconnect it prior to calibration.

The awkward part of this procedure is that the instrument will reject a calibration (indicated by "CAL Err") if any of these criteria are not met:

- a. Stability indicator must be extinguished.
- b. Reading must be all zeroes; no minus sign allowed.
 - + 0.000 acceptable
 - 0.000 not acceptable
- c. Rear panel thumbwheels set within range: 3, 3 is best.

CALIBRATION

- 1) Turn on and warm up. No air drafts or floor vibration!!
- 2) Tare to all zeroes, with a + sign.
- 3) Press the CAL button or lever. You must do this so gently that the stability is not lost. "CAL" will appear on the digital display.
- 4) Place Cal weight on pan, dashes are displayed.

AK/HK 160 -	internal (100)
PK-300 -	300 grams
PK-2000 -	2000 grams
PK-4800 -	4000 grams
PK-16 & 36-	special, see note below
- 5) When the display shows the value of the calibration weight (for example, 300.000 g , remove the calibration weight. Calibration is complete.
- 6) On the PK36 and PK60, the lever on the right side actuates the calibration software and lowers and internal weight. Enter calibration by CAREFULLY moving the lever, and holding it at the full-rotation position. Calibration is complete when the digital display shows the (internal) calibration weight value.
- 7) On PK 36 and PK60 only, the internal calibration weight is applied through a fulcrum system. This system makes the calibration adjustable, by moving the calibration weight along the fulcrum arm.

(Continued next page)

AK, PK, and HK -- Calibration (continued) / Mettler

Linearity

All of the K series instruments use similar cells, connected to various mechanisms to result in various instrument capacities. Since the cells are similar, the method of adjusting linearity is the same for all. At the rear of the cell, notice four 3MM hex-head screws. The outer ones adjust cornerload by moving the "termination" of the guides vertically. The inner pair allows the mounting of the null indicator board to move vertical, which effects linearity.

1. Compare readings from 0 to 1/2 scale, and 1/2 scale to full scale. Be sure that your readings don't introduce errors due to the tolerance of the test weights themselves.

2. If the first reading (0-1/2) is larger than the second (1/2- full), then the hexes need to rotate clockwise (CW). Make very small adjustments, as the sensitivity can be extreme. Rotate CCW if the first reading is smaller.

3. Since the beam of the cell "follows" the position of the null indicator board, it is possible to make the entire system non-functional by adjusting the null indicator outside the range of the beam. The range of the beam is adjustable via a "stop", located on top of the cell's cylindrical core. Adjust carefully !!!

AT -- Calibration and Calibration Mode Selection / Mettler

Background:

1

The Mettler user's booklet is highly recommended to anyone attempting to use the instrument's programmable functions.

2

The instrument has 3 modes of calibration: internal automatic, internal non-automatic, and external. *The three are mutually exclusive.* One of the three modes must be functional. The selection of the calibration mode is a separate process from actually performing the calibration.

Calibration Mode select:

- a. Press and hold (P&H) the Menu/Configuration button until Conf shows on the display.
- b. Press and release (P&R) the Menu/Configuration button repeatedly until Scale shows on the display.
- c. P&R the Select 1 button repeatedly until the tiny CAL word is indicated on the display. Notice that this indication will be above the large letters being indicated simultaneously, so look carefully.
- d. P&R the Select 2 button repeatedly until the desired choice of calibration mode is indicated: Auto-on, Auto-off, or uSEr. With the desired selection showing, P&R the Set button (on the left end of the TARE bar).

Calibration

The specific sequence of events in the calibrating process are different for different calibration configurations. These instructions will presume the uSEr calibration mode (user's external calibration weight) in enabled in the configuration.

- a. P&R the Menu/Configuration button repeatedly until uSEr shows on the display.
- b. P&R the SET function (left end of TARE bar).
- c. Follow the prompts from the display: a blinking display indicates that the instrument is waiting for the operator to do something. Example: blinking 200.0000 is the instrument prompting the operator to put 200 grams on the pan.

AT -- Packaging and Glass Doors / Mettler

Warning

Mettler uses specially shaped glass doors on these instruments. Unless the instrument is shipped using the precautions below, the glass doors will almost certainly be broken. Cost of doors and glass alone is in the vicinity of \$1000. **IES does not need the glass to repair the instrument**, so please do not ship it to us. Please call us before you ship these instruments.

Remove glass:

- 1) Find a box to keep many small parts in. On the rear of the instrument, remove the three screws securing the back panel--one on the top, two on the bottom. Do not remove the two in the center. Remove the panel. Remove the two screws securing the rear feet.
- 2) Remove all door parts, and set these aside for safe storage. Be on the lookout for the **many small roller parts associated with the door**. Notice how this comes apart, since you will have to reassemble it later. Remove the display assembly which is secured with one screw (**Watch out**; it will "pop" forward and fall on the floor.) Remove the front glass too; it is secured with two screws.
- 3) From the rear (about 1/2" below the top, centered left to right), remove the brass post that extends from the rear towards the front. Remove the screw in front of the weighing pan which holds down that white metal shroud. Now the glass at the rear of the weighing chamber can be removed. Store it safely and don't ship it, or any of the glass, to IES with the rest of the instrument. Replace the back panel and rear feet.

To reassemble:

- 1) Same as the instructions in #1 above.
- 2) Top glass is "U" shaped. Reassemble the top door with rollers.
- 3) Start the top onto the instrument. Be sure the rollers on both sides are properly engaging the tracks. Then slide the whole top glass forward.
- 4) The "L" shaped side doors can now be slipped into the appropriate slots.
- 5) Attach rear leveling feet, and then the rear panel.
- 6) Attach front glass using two screws.
- 7) Attach display by plugging it in and securing with one screw from the bottom.

[7/14/98]

These instrument are extremely expensive and will certainly be damaged if shipped in an inadequate box.

BD Calibration

Required calibration weights:

BD202	200 g
BD601	500 g
BD1201	1000 g
BD6000	4000 g

1. Warm up instrument at least 1 hour. Lab balances work best in an environment which is temperature controlled continuously.
2. Remove all objects from the weighing pan, then tare to zeros.
3. Press and hold the Cal/Menu button until CAL appears on the readout, then release CAL/Menu.
4. After a stabilization period, the display will start flashing. Add the required calibration weight.
5. After a stabilization period, the display will flash zeros. Remove the calibration weight.
6. The display will show C done then return to normal weighing automatically.

Error Codes

upper dashes scale is overloaded, or cell is damaged.

lower dashes scale is underloaded, or cell is damaged.

Error 1 inadequate stability for operation in process
(calibration, taring, reference for piece counting)

Error 2 Wrong calibration weight

Error 3 Reference quantity too small for piece counting

Error 9 Instrument internal malfunction

BB -- Service / Mettler**Calibration / Span**

Plug in and power ON. Empty weighing pan. Tare to zeros.
 Press and hold REZERO until CAL shows on the display, then release REZERO.
 When the readout displays a blinking number, put that calibration weight on the pan.
 Wait for blinking zeros, then remove the calibration weight. The pan is now empty.
 The instrument returns to normal operating mode automatically.

Linearity

There is no linearity adjustment potentiometer. Mettler adjusts linearity using a special software package, which is not available outside of Mettler. Units with severe linearity errors are probably damaged. Small errors may be adjustable by IES, since we make a linearity correction circuit board. IES can rebuild these cells.

Cornerload

Adjust cornerload using the same techniques as all force-restoration cells. This is explained in general terms in the IES Precision Weighing Handbook on page 8. On these BB cells, the cornerload adjusters are the two brass hex nuts with a smaller concentric slotted screw in the middle, at the rear of the cell. Turn the brass part, NOT the inner slotted screw.

Tolerances (in digits)

BB model	Cornerload Test Weight	tolerance	Linearity	
			up	down
120	100	3	2	4
240	200	3	2	4
244	200	3	2	4
300	200	3	2	3
600	500	3	2	4
1200	1000	3	2	4
2400	2000	4	2	4
2440	2000	4	2	4
3000	2000	3	2	3
3	2000	3	2	3

Failure Symptoms & Codes:

Flashing zeroes Damaged cell
 Error codes 1-8 Electronic failure in one or more circuits.

HL Balances -- Checklist for Shipping /**Mettler**

The following checklist will assist with packing Mettler HL balances. When these steps are taken, the chances for damage are reduced.

- () Remove the pan, pan brake, and pan brake cover. Place them in a separate box or bag so that they cannot break glass during transit.
- () Tape the sliding glass doors in the open position, so that they are protected by the metal sides of the balances.
- () Notice the gold hairwires towards the rear of the beam. Be very careful of them during all subsequent steps.
- () Move the "slide", which arrests the release beam, to the arresting position. It will be necessary to lift the release beam slightly, in order to engage the slide to the release beam. The slide is located below and to the left of the release beam. After engaging it, lock it in place with the securing screw.
- () Dial all weight dialing knobs to their maximum number.
- () Place the "reinforcing bracket" (located to the right of the weight set) in its upright position, and turn the brass set screw at the center of the stirrup to its clockwise position. () Swing each of the transport locks, located at the rear of the release beam, underneath the beam. Swing the wire on the right transport lock so that it engages the post immediately to the right and rear of it. Secure the transport locks their screws.
- () Slide each of the holders, located towards the front of the release beam, so that they secure the beam. Fasten them in place with their screws.
- () Rotate each of the 3 latches to their position beneath the suspension plate. Secure with their screws.
- () Place the entire balance inside a plastic bag. Place the unit inside a box specifically intended for shipping analytical balances.
- () At all times, use common sense in handling precision equipment. It is very delicate, and requires care in handling to prevent needless damage.

LJ16 and LP16 Infra-Red Dryer / Mettler

START key - Starts all drying operations. Lighted & flashing - ready. Lighted steadily - Drying
It is NOT possible to start drying without a sample on the weighing pan.

STOP key - Stops any operation.

Change Temperature: (Must be done PRIOR to starting dryer)

- 1 - Press "Thermometer" key.
- 2 - Press up or down key to adjust temperature.
- 3 - Finalize temperature selection with "ENTER" key.

Change Drying Time: (Must be done PRIOR to starting dryer)

- 1 - Press "Clock" key.
- 2 - Press up or down arrow key to adjust drying time.
- 3 - Finalize time selection with "ENTER" key.

Problems

ERR 0 - Cause: Settings (temperature , time, etc.) not finalized with "ENTER"
Solution: Finish entering parameters with "ENTER" before attempting to dry.

ERR 1 - Cause: Sample has been tared to zero, or the sample is too small initially.
Solution: Add material to pan prior to drying (minimum 100 digits on display)

ERR 2 - Cause: Dryer cover open.
Solution: Close cover prior to drying

Settings which are selected by the user (temperature, time, etc.) are stored only after they have been used once . If you expect to use settings or modes again in the future, you must use them once, otherwise they are lost.

Modes d/10, d/20, and d/30 will shut off the heat when the rate of change in the sample weight decreases below a threshold. If the user finds that the shut-off is premature, then the d/30 mode should be tried. Consult the Mettler [Installation & Operation Instructions](#), page 11.

With dryer mounted but not drying, the readout on the balance should be stable. If not, verify that the stem (support under dryer pan) is adjusted so that the dryer pan does not touch or rub against any surface. The draft shield (metal shroud around the pan) must be properly seated.

The push-button panel switches may not actuate with a delicate touch. Push directly in the middle of the buttons.

Obtain a replacement USER MANUAL from Mettler at (800) 638-8537.

ME30

This instrument weighs to a millionth of a gram - a microbalance.

The knob on the right side (arrestment knob) sets the instrument to one of three modes. Use position 0 (arrested) when adding or removing items from the weighing pan. Release the instrument to position 1 for weighing. If the instrument needs to be moved, use position T. When you move any weight dial or the arrestment lever, do it slowly and gently.

These instruments demand a very good environment for best performance. Any air movement or temperature change is very detrimental. A very stable table and floor are essential. These instruments easily measure the force exerted by static charge on glass doors, the operator, or on the object being weighed. Take precautions to remove static charge.

Calibration

1. Arrest lever at "0" . Weight dials to 0. Move arrest lever to "1"
2. If necessary, dampen the weighing pan using the Panbrake button.
3. Press Zeroset (tare). The display should show 0.000 mg
4. Gently rotate the weight dialing knob to position "C", which will internally place a 30 mg weight on the weighing system.
5. Adjust the calibration potentiometer (right side, rear panel, a little above half way from top to bottom) until the display shows 30.000 mg.
6. Adjusting the calibration effects zero, so it may be necessary to repeatedly dial back to 0, then cycle through steps 3 - 5 again.

M3 -- Calibration / Mettler

The Mettler M3 microbalance is a substitution type of balance. The electronic weighing range is .1 gram. For unknowns greater than .1g, the knobs on the left are dialed to within .1 g, which adjusts internal weights accordingly.

These are extraordinarily sensitive instruments. The dual thickness glass on the front is to shield the weighing compartment from the heat of the person standing in front of the M3, which would cause air currents inside the compartment, due to convection. Stability of the weighing table is critical.

The knob on the right releases the unit between the Transport arrest state, the Arrest state, and the Weighing state. Only add or remove samples from the pan when the unit is Arrested. Never move the unit unless it is in the Transport arrest state.

To calibrate:

1
Verify that the knobs on the left are both at 0
Stabilize with no weight on the pan, TARE to 0.000 mg.

2
Find the small hole on the right end side of the display.
Without upsetting the stability(as indicated by the red light) , press the button inside the hole.

3
The display will show CAL.
Dial the lower left knob from 0 to C.

4
After the display goes to 100.000, return the lower left knob to 0.

These units are so sensitive that's it's very difficult to press the calibration button without upsetting the stability indicator; you have to be extraordinarily careful. If you do upset the stability, you'll get "CAL Err ". Press the REZERO button, and try again

M3 and UM3 microbalance - packing for shipment

Call IES for one of our specially made **analytical boxes**. It's the best way to take care of the instrument in transit. It's worth the wait. The box is free and we pay the shipping via UPS surface. If you want express shipping, we will ship it on your account.

- 1) On the front of the instrument, there is a glass plate held on with screws. That plate should be removed prior to packaging. Don't ship the glass, washers, or screws with the instrument. Keep them, and re-install them when the instrument is returned to you from IES
- 2) Inside the weighing chamber is the weighing pan itself. It hangs by a small hook near the ceiling of the weighing chamber. VERY carefully unhook the pan, and place it in a (small) box by itself. You might want to put a few styro peanuts in this small box with the pan, just for cushion. Don't lose the pan, it is no longer available. ***Please don't put the pan loose with the instrument – it will get lost.***
- 3) On the left side are the weight dials. Turn each of them to the highest number on each dial.
- 4) On the right side is the arrestment lever. It has three position: 0, 1, and T. Be sure it is in position T. ***This is extremely important.***
- 5) Place the instrument in a large plastic bag. Put 2 inches of cushion material (styro peanuts) in the bottom of the inner box, then place the bagged instrument in the inner box. Fill the rest of the inner box with loose fill so the instrument is cushioned everywhere.
- 6) Using the same technique as step 5, pack the inner box into the outer box.
- 7) IES recommends that you insure the box for the full replacement cost, which is in the range of \$10,000 to \$15,000 depending on exactly which model you are shipping

MT5 UMT5 Calibration

The following procedures presume that the instrument is configured under standard factory settings. If not, then the procedures will be different. For a complete copy of the Mettler user manual, visit the Mettler lab website at mtlabservice.com

A. Calibrate using internal weight

1. Repeatedly press the **MENU** key until **AUTO CALIN** **CAL INT** shows on the readout.
2. Press the **SET** key.
3. The draft shield will close automatically unless it has been disabled via the program menu. If it has been so disabled, close it manually .
4. The internal calibration sequence will progress automatically. It may take a minute or so. The instrument must be perfectly stable - no air drafts or table vibrations whatever. Upon completion, the display shows **CAL End** , and the instrument returns to normal operation mode automatically.

B. Calibrate using external weight

Unless the instrument has already been configured for external calibration (unlikely) , it will need to be so configured first, then calibrated. But think carefully before calibrating with an external weight. Ordinary "class S" or "ASTM 1 " weights are **much less** accurate than the internal weights. Only weights with known errors (via a calibration certificate) might be suitable for external calibration. External calibration is discouraged.

1. Press and hold the **CONFIGURATION** button . As soon as **CONF** shows on the display, release the key .
2. Press **CONFIGURATION** again , the display shows "SCALE"
3. Repeatedly press the **SELECT1** button to cycle through the **SCALE** menu to **CALIN**.
4. Repeatedly press **SELECT2** to select **USER** . Press the **SET** key to confirm.
5. Repeatedly press **MENU** until **CAL USER** shows , then confirm with by pressing **SET**
6. The display shows the required weight value (probably 5 grams). Place the weight on the pan .
7. When the display shows 0.000000 , remove the weight.
8. After reaching stability, a "beep" will signal that the calibration process is complete, and the instrument has returned to weighing mode.

PB / AB / SB Calibration - Mettler (new style)

Introduction

Configuration and calibration of these instruments is accomplished through the front keypad. Each key has two functions, depending on whether it is pressed momentarily, or pressed and held. Further, the keys will have a different function when in normal operating mode than when in a configuration-menu setting mode. The function marked in white lettering directly on the key is activated when the key is pressed and immediately released. The marking just below the key, in light gray, is activated when the button is pressed and held.

Key Marking		Momentary function	Press & Hold function
White	Gray		
On	Off	turns unit ON	turns unit OFF
→O/T←	Off	tare	turns unit OFF
↺↻	F	alternate or change setting	call function (only within a menu)
C→	Cal/Menu	print, or approve/accept setting	enter calibration or menu system

Calibration (span)

PB/SB/AB series do not have internal weights. The instrument will prompt you for the correct calibration weight, so you do **NOT** need to know that prior to starting the span calibration. Allow at least 30 minutes warm-up. Room temperature must be stable around the clock for best operation .

1. Start with weighing pan empty.
2. Press and hold the Cal/Menu key until "CAL" appears on the display .
3. The display will be flashing a number. Place a calibration weight of that value on the pan.
4. When the display flashes zeroes , remove the weight.
5. Instrument returns to normal weighing mode automatically .

Cornerload

Mettler may use either of two general types of force-restoration cells in this instrument group.

1- Monoblock type cell

If the front panel says "Monoblock", then the cell is a one-piece type. Consult the instructions on page 8 . Be forewarned that it is possible to ruin the cell by less than skillful adjustment. The resultant damage can be extremely expensive.

2 – Assembled cell, with adjustments

If the cell is not monoblock, then follow the standard cornerload adjustment instructions on page 7

continued, next page

PB , continued

Linearity

Linearity is not adjustable in the field. Call IES at (800) 541-0852 .

Error Codes

Display error code	Cause or Correction
dashes	pan not properly placed, or damaged cell
error 1	inadequate environment (vibration, air draft, etc) or defective electronics
error 2	wrong weight in calibration
error 3	improper reference weight or number in piece counting mode
error 5	compatibility problem with internal software and external peripherals
flashing zeroes	wrong or misplaced pan, or electronics failure
Abort	calibration adjustment stopped before finished

PB -- Calibration / Mettler (old type)

Mettler has produced TWO series of instruments with the "PB" designation. This note applies to the older series (PB30, PB300, PB3000, all with red LED type displays). If the model you have isn't one of these, then it's the new type. Consult the " PB/AB/SB Calibration-Mettler (new style) " article elsewhere in this book

Linearity

The linearity adjustment potentiometer is located on the main circuit board, adjustment facing upward, about half way from front to back.

Calibration (fine) [This is the span adjustment procedure that will normally be used in field service.]

1

Locate the small hole on the rear, near the lower right corner

2

Adjust the pot for accurate readings with full load on the pan.

It will be necessary to adjust the pot, then re-zero and adjust again, since the pot will effect the zero.

Calibration (coarse)

1

This procedure requires that you have a wide range of precision 1% metal film resistors available, as well as an accurate ohm meter and decade box. Without them, you won't be able to complete the adjustment.

2

Locate the power resistor mounted to the floor of the instrument , near the main circuit board.

Remove the small 1% resistor (s) that are connected in parallel with the power resistor.

3

Measure that resistor that was removed. Adjust the decade box to that value, and connect the decade box in parallel with the power resistor. **WARNING:** Don't adjust the decade box to a value less than 500 ohms at any time in this procedure.

4

Adjust the pot on the rear to approximately the center of it's rotation range. With the unit operational, adjust the decade box so that the unit is accurately adjusted for span. Unplug, then note the settings of the decade. Select a resistor of that value, and install it in the place of the resistor that was previously removed.

PB (old style) and PL Instruments -- Installation of HDSP / Mettler

Replacement of digital display LED's

The PL and PB instruments used Litronix DL-721 and DL-727 display devices, which are no longer manufactured. Hewlett Packard's HDSP-5321 and Quality Technology MAN6910 are pin compatible with DL-727, but have slightly larger numerals. There is no substitute for the DL-721.

DL-721	+, -, 1, 8	no replacement
DL-727	8, 8	HP # HDSP-5321

The display boards for these instrument are frequently damaged during repair, here are precautions to avoid those problems.

1) The reason the boards are damaged is that it is difficult to fully detach the DL-device before pulling it away from the board. If it isn't fully detached, it will pull the copper runs off the board, which may not be repairable.

2) Careful desoldering is required, and the right tools. You will need solder wick, a soldering iron with a CLEAN tip, and a pair of stout needle nose pliers.

If you change these devices frequently, consider this special tool: A pair of small wire cutters (such as Diamalloy MS-54-3) can be intentionally dulled, so that it can grab very small wires tightly without cutting through them.

3) From the back side of the display board, use solder wick to remove the solder from all 18 holes. When a hole is really clean, you will be able to wiggle the lead in the hole. A minute amount of solder tends to keep the lead stuck to the inside of the hole. Use the dulled wire cutters, or stiff needle nose, to grab the lead and un-stick it from the wall of the hole. As long as there is solder attaching the lead to the hole, removal of the DL will damage the board.

You may have to re-fill a hole with solder, and re-desolder the lead. Solder wick works best when it has enough solder to start the flow.

Of course, if you have a vacuum desoldering station, use that to clean the holes.

When all 18 leads are free, the DL device will pull away from the board, and a new one can be installed and soldered.

PC -- Temperature Compensation / Mettler

1. Adjustment of temp. comp. is required ONLY when a main board or measuring cell is being replaced. The reason is that the cell and board have to be matched. If an instrument is drifty, it's probably because of a mechanical or electrical defect, and that will not be corrected by adjustment of temp. comp. *Adjusting temp. comp. needlessly results in an instrument which still has the original mechanical/electrical problem, but is now ALSO out of compensation; DOUBLE TROUBLE!* Don't adjust temp. comp. unless you're sure you need too.

2. There are two aspects of temperature compensation, one is compensation of the CALIBRATION, the other is compensation of the ZERO POINT. The two procedures are separate, and CALIBRATION is always done first.

R10 - compensation of calibration rear-most vertical pot
 R65 - compensation of zero point middle vertical pot
 R33 - linearity ----- front vertical pot
 R3 - span ----- rear-most pot, horizontal
 (rear access)

3. The process of adjusting either compensation requires taking readings under hot and cold circumstances, and methodically recording the results. A chart is indispensable. The chart looks like this:

Reading	HOT /COLD	Time
4000.7	C	8:30 AM Monday
4001.5	H	12:30 PM
adjusted R10 1/2 turn CCW		
4002.2	H	12:35 PM
unplugged		
4002.0	C	4:35 PM
adjusted R10 1/8 turn CCW		
4002.4	C	4:55 PM
4002.4	H	8:50 AM Tuesday

4. The table above is an example of how a sequence of calibration temp. comp. readings might look. The technician makes an adjustment of the pot based on both the DIRECTION (up or down) of the drift, and the amount of drift. If, after a set of readings, the drift gets worse, then turn the pot in the opposite direction.

Don't try to rush the process by heating with a hair dryer or lamp. It takes several hours for the temperature around the cell to penetrate to within the cell.

(Continued next page)

PC -- Temperature Compensation (continued) / Mettler

5. Notice that, when doing calibration temp. comp., you can get readings as the instrument warms or cools. **YOU MUST** take a new reading of the calibration after adjusting the pot, since the setting of the pot effects the calibration.

6. Use a similar chart for zero-point temp. comp., but there will be no weight on the pan during the adjustment procedure. It's important that the instrument never be TARED during the zero-point, since that resets the display to zero. The whole idea of the procedure is to maintain zero without need of TARE.

Of course, you can only take readings of zero-point drift as the instrument warms up, not when it's cooling off. The reason is that you have to unplug the instrument in order to make it cool down, and that means it will be re-tared when you power-up.

PC -- Calibration and Linearity / Mettler

The PC group (includes AC-88 and AC-100) encompass a wide range of capacities and resolution, from 80 grams to 24 Kg.

The top loader types, (with chassis about 11" deep by 7" wide by 4" tall) have the circuit board on the right side of the instrument, running from front to back. There are four pots on that main board. **The calibration** pot is mounted on the main board, but is accessible through a hole near the **right rear upper corner**. The other three pots on the board are only accessible after removing the instrument top cover (large screw under the pan). Of those three pots, the front one is linearity, the other two are temperature compensation. **DON'T** adjust the temperature compensation unless you **KNOW** that the rest of the instrument is in good condition, **AND** you know how to adjust temp. comp. in general. Definitely **DO NOT** try to "fix" instruments which are drifty by adjusting drift with these pots!

The larger capacity types have a larger chassis (about 14"x11"x5"). The circuitry is similar, but mounted differently. R10 is the **calibration pot**, and is accessible from the exterior on the **right hand side**. The other three pots are mounted near the front right corner on the main board, R13 is linearity and is the front-most in the group of pots. Don't adjust the other pots!

Mettler used a "trim resistor" on all the PC instruments, which is effectively a coarse calibration trim. After the trim resistor is correctly selected, the instrument can be calibrated with the calibration pot. The trim resistor is R11 on the toploaders, R3 on the high-capacity types. Technicians should be suspicious of any instrument that needs a new trim resistor, since it shouldn't need replacement except when critical circuit board repairs are made. In any case, use only 50ppm TC precision resistors .

The AC/PC series has a group of 5 slide switches located towards the front of the main circuit board. The slide switches are set differently for different models. The chart below shows switch settings for specific models. When microprocessor 41375 is installed **AND** the switch settings are in a position designated for a specific model, that model number will be displayed on the readout when the instrument is turned ON. If the switches are not set at a designated model, the readout will show all 8s at turn on. If uP 41109 is installed, no model number will be displayed. The following data recorded for board ME41384 /ES41383 with ME41375 microprocessor. Other boards or other microprocessors will function differently.

Switches are numbered 1 to 5 from bottom to top. On=Rear , Off=Forward

switch	model
12345	
00000	AC100
00001	PC400C
00010	PC180
00011	PC440
00100	PC2000
00101	PC4400
00110	PC8000
00111	PC16

All other switch combinations - No model designated.

PC2000, PC4000, PC4400 -- Guides Made By IES Corp.

Mettler no longer sells the former 41189 part; upper and lower guide for the popular PC-2000/4000/4400 series of instruments. However, these instruments can be salvaged when guides are broken. IES makes a replacement guide that can return the unit to full performance operation.

An exchange program allows technicians to replace damaged 41189s in the field. Under this program, IES supplies remanufactured 41189 assemblies in exchange for defective components. The damaged components are refurbished with new flexible bearings made by IES.

Because IES has a limited number of rebuildable cores, all parts are sold with the understanding that the defective parts being removed from instruments will be returned to IES. IES does not sell 41189 components on any non-exchange basis. IES can provide parts prior to receiving the recyclable component on a limited basis.

Cost of the IES 41189 component is \$115.

IES manufactures 41189 components using precision alignment fixtures. Dimensions, parallelism and flatness are controlled to precision tolerances. Repaired instruments can meet original accuracy performance requirements when properly installed.

IES guarantees that parts meet IES manufacturing specifications, no other warranty is expressed or implied. It is the responsibility of the installation technician to install components with skill and craftsmanship. IES recommends installation in accordance with Mettler Service Manuals.

PE Lab Balances -- Calibration / Mettler

With the exception of the PE-200,2000,400, and 4000, the Mettler PE group calibrates by placing a calibration weight on the pan, after initiating an automatic calibration cycle. The 200/2000/400/4000 group is calibrated manually by means of an adjusting screw at the right front corner.

To calibrate PE instruments (other than 200 etc.) , proceed as follows.

- 1 Plug in the instrument and warm up at least 10 minutes.
- 2 Push "TARE", so that the instrument shows zero weight.
- 3 Again push "TARE", but this time hold TARE down until the horizontal lines appear across the display. When the lines appear, release the TARE bar.
- 4 The letters CAL will appear. After they do, apply a calibration weight to the center of the pan. After several seconds, the calibration weight will appear on the display. Calibration is complete.

PE Model	Calibration Weight
160	100 gr.
300	100
360	100
600	500
1600	1,000
3000	1,000
3600	1,000
6000	2,000
6	2,000
11	4,000
12	4,000
16	4,000
24	4,000
CE-150	20

To calibrate PE-200/2000/400/4000, adjust potentiometer R32 (front right corner) until accurate calibration is achieved. Adjustment of R32 will cause "zero" to shift, so re-zero after each adjustment before checking calibration. There are 2 other "pots" close to R32, don't adjust them mistakenly! R32 can be distinguished by it's larger size.

To change **Unit of Measure** on PEs other than 200,2000,400,4000

Press and hold the TARE bar while plugging in the instrument. Hold the TARE bar down while the various units of measure cycle past on the display. Let off the TARE bar only when the unit you want appears. From that time on, the unit will power-up in that unit. Calibration will continue to be with the gram weight indicated above.

PE -- Pots & Boards / Mettler

There are many instruments in the PE series, with resolution from .001 gram to 1 gram. Many individual models use the same circuit boards as other models in the series, but many are different too. Be especially careful NOT to interchange boards between different models unless both are using the same part number of board (as indicated on the yellow tag, on the underside of the board). Although different boards may at first appear to be functional between different instruments, a more careful observation will show that the instrument continues to drift, and can't be compensated.

		Board Number VS. Instrument Model & Potentiometers					
Board Number	47823						
	47050	47507	48391			48391	
	48334	47662	48979	47818		45755	
	47484						
PE Model	160	200	11	160A		FE HD	
	360	400	12	1600A		FE HD2	
	600	2000	16				
	1600	4000	22				
	3600		24				
	6000						
Pots							
Linearity	R60	R34	R57	R61		R57	
Calibration	SOFT	R32	SOFT	SOFT		SOFT	
TC CAL	R59	R33	R59	R60		R59	
TC ZeroR64	None	R58		R65		R58	

Notice that most instruments in the PE family have software calibration, so no calibration pot exists for that function in those models. (PE 200, 2000, 400, 4000 do use a pot)

Generally, the TC CAL and TC Zero pots shouldn't be adjusted. Adjustment of them is a lengthy process involving careful record keeping of temperature and associated drift. And definitely DO NOT try to make drift instruments stable by adjusting temp. comp. Adjusting TC will never correct the effects of defective mechanical or electronic components. Be forewarned!

This table shows various PE models (except 200, 2000, 400, 4000) and associated calibration weight.

Model	Cal Wt.	Model	Cal Wt.
160, 160A	100	11	4 Kg
360	100	12	4 Kg
600	500	16	4 Kg
1600, 1600A	1000	22	4 Kg
3600	1000	24	4 Kg
6000	2000	FEHD, 2	4 Kg

The calibration procedure for these is

- 1 Press and hold TARE until - - - - is indicated, then release TARE.
- 2 Place the appropriate weight on the pan.
- 3 Wait for the instrument to display the calibration weight WITHOUT flashing. Normal operation resumes automatically.

Cornerload is adjusted via a brass hex nut near the rear corners of the cell. Use the standard procedures for adjusting cornerload. However, note that, at the rear of the chassis there is a metal plate that can be removed via two screws on the underside of the chassis. Remove the plate, then notice that the cornerload adjustment is locked in place by a rectangular metal plate behind each hex adjuster. These plates are on the rear of the cell, and can be loosened. Loosen both before adjusting cornerload.

PK, AK, HK -- Calibration / Mettler

This was Mettler's first instrument to use software calibration. Accordingly, it is somewhat less "user-friendly" than their latter versions. If the instrument has any external devices connected (printer, etc.), then you **MUST** disconnect it prior to calibration.

The awkward part of this procedure is that the instrument will reject a calibration (indicated by "CAL Err") if any of these criteria are not met:

- a. Stability indicator must be extinguished.
- b. Reading must be all zeroes; no minus sign allowed.
 - + 0.000 acceptable
 - 0.000 not acceptable
- c. Rear panel thumbwheels set within range: 3, 3 is best.

CALIBRATION

- 1) Turn on and warm up. No air drafts or floor vibration!!
- 2) Tare to all zeroes, with a + sign.
- 3) Press the CAL button or lever. You must do this so gently that the stability is not lost. "CAL" will appear on the digital display.
- 4) Place Cal weight on pan, dashes are displayed.

AK/HK 160 -	internal (100)
PK-300 -	300 grams
PK-2000 -	2000 grams
PK-4800 -	4000 grams
PK-16 & 36-	special, see note below
- 5) When the display shows the value of the calibration weight (for example, 300.000 g , remove the calibration weight. Calibration is complete.
- 6) On the PK36 and PK60, the lever on the right side actuates the calibration software and lowers and internal weight. Enter calibration by **CAREFULLY** moving the lever, and holding it at the full-rotation position. Calibration is complete when the digital display shows the (internal) calibration weight value.
- 7) On PK 36 and PK60 only, the internal calibration weight is applied through a fulcrum system. This system makes the calibration adjustable, by moving the calibration weight along the fulcrum arm.

(Continued next page)

PK, AK, HK -- Calibration (continued) / Mettler

Linearity

All of the K series instruments use similar cells, connected to various mechanisms to result in various instrument capacities. Since the cells are similar, the method of adjusting linearity is the same for all. At the rear of the cell, notice four 3MM hex-head screws. The outer ones adjust cornerload by moving the "termination" of the guides vertically. The inner pair allows the mounting of the null indicator board to move vertical, which effects linearity.

1. Compare readings from 0 to 1/2 scale, and 1/2 scale to full scale. Be sure that your readings don't introduce errors due to the tolerance of the test weights themselves.
2. If the first reading (0-1/2) is larger than the second (1/2- full), then the hexes need to rotate clockwise (CW). Make very small adjustments, as the sensitivity can be extreme. Rotate CCW if the first reading is smaller.
3. Since the beam of the cell "follows" the position of the null indicator board, it is possible to make the entire system non-functional by adjusting the null indicator outside the range of the beam. The range of the beam is adjustable via a "stop", located on top of the cell's cylindrical core. Adjust carefully !!!

PG , SG Calibration and menu blocks - Mettler

Calibration – Internal

Press and hold CAL button till CAL Int is displayed
Cal Done will be displayed and automatically return to weighing mode.

Calibration – External (Vari Cal)

Press and hold CAL button till VARI Cal is displayed
Balance will prompt you to select external weight
'F' button will change the desired calibration weight .
Press Menu button to confirm external weight.
Balance will prompt you for the external weight – place weight on pan.
Flashing zeros 0.00g will signal you to remove weight.
Balance will return to normal operation.

MENU

Press and hold the MENU button until "MENU" is displayed.
Menu button will now cycle through these option blocks
Function -----piece counting, percent weighing, formula weighing
Weigh Unit 1 -----g, mg, kg, lb, oz, ozt, GN, dwt, ct, mo, m
Weigh Unit 2 ----- g, mg, kg, lb, oz, ozt, GN, dwt, ct, mo, m, Htl, Stl, ttl
Vibration Adapter-----1, 2, 3
Weigh Process Adapter-----1, 2, 3, OFF
Repeatability-----Good, better, best, Std
Automatic Shutdown-----Aoff, Aoff 2 minutes, Aoff5 min., Aoff10 min.
Adjustment (Calibration)--Cal int, VariCal, test int, test E
Auto Adjustment-----Info ON, Info OFF
Power-Up Mode-----Qu Start, Fu Start
Auto Zero-----AZero, no AZero
Settings-----Restet

'F' key will cycle through the options in each individual block.
Press and hold Menu key until the balance reverts to weigh mode to store any changes.

PG SG Calibration / Mettler

Introduction

The keypad of the PG/SG instruments has several keys. The primary function is symbolized by the bold lettering, and is actuated by briefly pressing the key. The secondary function is symbolized by the smaller marking, and is actuated by pressing and holding the key until the function starts. Keys often have different function when in normal (weighing) mode than in menu (configuration) mode.

Key Marking bold light	Momentary function	Press & Hold function
On Off	turns unit ON	turns unit OFF
→O/T←	tare	
C	return to weighing mode, without saving	
↶↷ F	alternate or change setting	call function (only within a menu)
C→ Menu	print, or approve/accept setting	enter calibration or menu system
1/10d Cal	change display resolution	enter calibration mode

Note: **Press** means to momentarily press a button, and release immediately

Press and hold means to press and continue pressing a button, until the desired action happens.

Internal Calibration

Most units will be found with the factory default configuration, which means that internal calibration will be enabled.

1. Press and hold the " 1/10d CAL " button until "CAL Int " shows on the readout.
2. The display will show dashes, then zeroes, then dashes again, then "Cal done ". The unit returns to normal weighing mode automatically.

External Calibration

In order to calibrate to an external weight, external calibration must first be enabled (configured), then performed.

1. Press and hold the "C→ Menu" key until "MENU" shows on the display.
2. Repeatedly press the "C→ Menu" key until one of the four adjustment modes shows on the display. The four are: CAL Int test E test Int VariCal
3. When one of the four choices shows, select this menu group by pressing the "double curved arrow button" ↶↷
4. Repeatedly press the "C→ Menu" button to cycle through the choices. When "VariCal" shows, select that choice using the "double curved arrow" button ↶↷ .
5. Press and hold the "C→ Menu" button until the unit returns to the normal weighing mode (External calibration has now been configured)
6. Press and hold the "1/10d Cal" button until "VariCal" shows on the display .
7. The display will flash a weight value. Place this weight on the pan..
8. The display will show dashes, then flashing zeroes, then "CAL done". It returns to normal weighing automatically.

continued

continuation of Mettler PG/SG Calibration adjustments

Cornerload

Mettler may use either of two general types of force-restoration cells in this instrument group.

1- Monoblock

If the front panel says "Monoblock", then the cell is a one-piece type. Consult the instructions on page 8. Be forewarned that it is possible to ruin the cell by less than skillful adjustment. The resultant damage can be extremely expensive.

2 – Assembled construction, with adjustments

If the cell is not monoblock, then follow the standard cornerload adjustment instructions on page 7

Linearity

Linearity is not adjustable in the field. Call IES at (800) 541-0852 .

Error Message	Cause and Solution
dashes	pan not correctly installed , or damaged cell
none F	"Function" mode has been started, but no function selected. See operator manual
error 1 or error 9	verify that environment isn't causing instability. Otherwise, electronic malfunction
error 2	Incorrect calibration weight , or electronic malfunction
error 3	choose a different reference number or weight in piece counting mode
flashing zeroes	missing or incorrectly mounted pan, or cell damaged
abort	unstable during calibration. Push C to clear. If can't complete, then electronic failure

PM -- Configuration / Mettler

The PM series of instruments can operate in various modes (alternate units of measure, display resolution, data communication, etc.), and all of those parameters are set from the front panel using the TARE bar.

To change data communication parameters:

Important notes:

- a. You have to finish the whole procedure, **not stop after you've set the parameter** **you want**, since the setting won't be stored unless you finish.
 - b. You can skip any selection step by continuing to press and hold, rather than letting off the TARE bar and entering the selection group at that step.
 - c. Default settings in are shown in *italics*
- 1 Start with the unit turned OFF (display is blank)
 - 2 Press and hold (p&h) the TARE bar, until the display shows CONF , then release.
 - **if the balance turns on to the normal weighing mode, you will need to turn the power off, remove program cassette. Remove jumper on bottom side of cassette.**
 - **Reinstall cassette. Re-apply power and try again.**
 - 3 Press and release (p&r) TARE repeatedly until IFACE shows on the display.
 - 4 P&H until S shows, then p&r repeatedly until the transmission criteria you want shows:

choices are:

<i>Stb</i>	transmit next valid data only when stable, and only with external print signal
All	transmit current data when stable, only with external print signal
Auto	Stable values after change, only with external print signal
Cont	All data transferred regardless stability or external print request.
 - 5 P&H until *b* shows, then p&r to select desired data rate (must match external computer)

2400
 - 6 P&H until *p* shows, then p&r to select even or odd parity (*E* or *O*)
 - 7 P&H until PAUSE shows, then select between pause times *I*
 - 8 P&H until AU shows, select ON or *OFF* (this is certification symbol format, select ON if you are using with LP16 dryer , etc.)
 - 9 P&H until End shows, continue p&h until the unit shows zeros on the display. The unit has returned to normal operation and the parameters you have selected are now in effect.

PM — Piece Counting / Mettler

Setting Unit 2 to PCS

1. Unplug balance.
2. Press and hold TARE bar, plug in balance.
3. When display shows –Conf- release tare bare – display shows rESET.
4. Press and release TARE bar until you see UNIT displayed.
5. Press and hold TARE bare until you see Unit 2 , release TARE bar.
6. Press and Release TARE bar until PCS unit is displayed.
7. Press and hold TARE bar until END is displayed, Release TARE bar.
8. Press and hold TARE bar until balance reverts to weighing mode.

Setting Reference:

1. Place a container on the pan, if one is required or leave pan empty TARE balance.
2. Add 10 pieces to be weighed on the pan, or in container.
3. Press TARE bar until –Set 10 PCS- appears. Reference will be stored.
4. Remove the reference pieces and the balance is ready for counting.

[4/14/98]

PM, PJ, AM, AJ Balances -- Calibration and Error Codes / Mettler

- 1) Switch on instrument. TARE the instrument by pressing and releasing the control bar.
- 2) To calibrate, press and hold the control bar until -CAL- shows on the display, then release the control bar. (The display will show - - - - -)
- 3) The display will flash a number. Place that amount of weight on the pan.
(display will show - - - - -)
- 4) When the display flashes 0.0g ,remove the calibration weight.
(display will show - - - - -)
- 5) When the display shows 0.0g , the calibration procedure is complete, and the instrument is calibrated

Linearity

There is no linearity pot. Contact IES if linearity is bad. Generally, poor linearity indicates either a defective part within the measuring cell, or else an electronic problem. In either case, IES's special linearity correction board will be useful.

Configuration

Many operating aspects of the instrument, such as integration time, communication parameters, etc, are adjustable from the front panel. There are so many settings possible, that a complete review is beyond the scope of this manual.

Access weighing stability parameters (weighing process or vibration sensitivity) by continuing to press the TARE bar at step 2 above. Change weighing process parameters by letting off of the TARE bar when the "droplets" appear on the display, then sequence through possible settings by repeatedly pressing the TARE bar. Change vibration sensitivity by letting off of the TARE bar when the double-curved symbol appears. Cycle through possible choices by repeatedly pressing the TARE bar.

Access printer configuration, resolution parameters, units of measure, and communication settings by starting with the instrument OFF, pressing and holding TARE until CONF appears on the display, then use the TARE bar to cycle through various settings.

Error codes

When the unit is non-functional, it is programmed to show "error codes" on the display. Since nearly all of the circuitry is on the main board, that is almost invariably the source of the problem.

Error code	Interpretation
1,2,5,or 6	Faulty main board.
4	Temperature compensation error / bad main board
3	Error reading cassette; bad cassette or cassette not plugged in.
8	EEROM data missing / bad main board
9	EEROM program data error / bad main board

PR / SR Calibration - Mettler

These instrument are normally (factory default) configured to utilize internal calibration. Unless they have been re-configured, this is the configuration instruments will be found in.

Introduction

The keypad of the PR/SR instruments has several keys, as well as a series of horizontal lines just below the readout. Keys which have green lettering have two functions. The primary function is symbolized by the white lettering, and is actuated by briefly pressing the key. The secondary function is symbolized by the marking in green, and is actuated by pressing and holding the key until the function starts. Keys often have different function when in normal (weighing) mode than in menu (configuration) mode.

Key Marking white green	Momentary function	Press & Hold function
On Off	turns unit ON	turns unit OFF
→O/T←	tare	turns unit OFF
C	return to weighing mode, without saving	
↶ F	alternate or change setting	call function (only within a menu)
C→ Menu	print, or approve/accept setting	enter calibration or menu system
1/10d Cal	change display resolution	enter calibration mode

The horizontal lines cover a series of keys. During configuration, various words will appear on the display directly above these lines. **Pressing on the lines selects the word on the display.** In this way, the switches beneath the lines can have various functions, depending on where in the configuration system they are used.

Internal Calibration

Calibration with the internal weight can be initiated by pressing and holding →0←. After "Start" shows on the display, press the lines below the word "Calibration". The display will show "Balance Calibration", then " Cal done ". The unit returns to weighing mode automatically.

continued, next page

PR Calibration adjustments, continued

External Calibration

Calibration to an external standard requires that the instrument menu system be accessed to put it into this mode. When using the menu system, selection choices will appear on the digital readout. Select a single choice by pressing the key directly below it . (NOTE: Sometimes, not all choices are visible, since they don't fit on the alpha-numeric display. In that case, pressing the key below the right-facing arrow will expose those choices)

1. Press and hold the C→ menu key until "MENU" appears.
2. Display shows "APPL WEIGH CAL SYSTEM ▶" Press the lines below "CAL"
3. Display shows " Configure / Test Calibration " Press the lines below "Calibration "
4. Display shows " FACT CAL Int VariCal ▶ " . Press the lines below "VariCal " .
(the unit may jump to step 6 automatically)
5. Display shows " VariCal / ExtWgt InfoOn InfoOff " , press the lines below "ExtWgt " .
6. Display shows various weight choices , press the lines below the desired choice .
7. Press and hold the "C→ Menu" key until "Stored" appears on the display
8. The unit will return to the normal weighing mode.

Note: The preceding steps changed the instrument calibration configuration from internal to external..
The following steps will calibrate the instrument to the external weight .

8. Press and hold the " →0← Cal/Test " button until "Start / Test Calibration Repro " shows.
9. Press the lines beneath the word "Calibration" . The words "Balance Calibration " appear.
10. The display will flash a number. Place a weight of that value (number) on the pan .
11. When the display flashes zeroes, remove the weight .
12. The display will show " Cal done " . The instrument returns to weighing mode automatically .

Cornerload

Mettler may use either of two general types of force-restoration cells in this instrument group.

1- Monoblock construction

If the front panel says "Monoblock", then the cell is a one-piece type. Consult the instructions on page 8. Be forewarned that it is possible to ruin the cell by less than skillful adjustment. The resultant damage can be extremely expensive.

2 – Assembled construction, with adjustments

If the cell is not monoblock, then follow the standard cornerload adjustment instructions on page 7

Linearity

Linearity is not adjustable in the field. Call IES at (800) 541-0852 .

PT Calibration & Cornerload adj (Old-Style Mettler PT)

Warning

The instrument has two covers; one over the front (gray), and one over the rear (black). This warning pertains to the front. If you need to remove the front cover, be sure to detach the pan and its sub-pan, prior to loosening the cover. This front cover slides as it is removed, and will push against the pan stems unless the pan is removed first. Don't lose the screws, they're special!!

REMOVAL OF FRONT COVER

First remove the two screws in the top of the rear cover. After doing so, it will tilt backwards, revealing two latches. These latches are located near the bottom of the back of the front cover; one on each side. Pushing each latch forward will release the front cover, so that it can be lifted away. Return them to the rear position when you replace the front cover.

CALIBRATION

The calibration pot is on the right side, near the bottom, about 2 inches from the front. Adjust the pot for accurate calibration/span.

CORNERLOAD

*** WARNING***

When securing the locking nut on the top of the cornerload -adjustment post, it's easy to tighten to hard, which breaks the threaded shaft. That would probably cause the instrument to wind up in a trash can.

Method 1:

Place a weight equal to full capacity near the front of the pan, but not overhanging the edge. Tare to all zeros. Move the weight towards each of the cornerload adjusting post, but not so far as to overhang the edge of the pan.

Adjust whichever deviation is largest first. If the deviation is +, then the mounting of that corner must move down. SLIGHTLY. Loosen the locking nut on top of the Cornerload adjusting post, rotate the cornerload adjustment (underneath the end of the flex-arm) clockwise, then tighten (gently !!!) the lock. Recheck cornerload. For - deviation, the corner mounting must move up, instead.

Method 2: Look at any Mettler manual, and orient the pictures for cornerload so that they match the orientation of the cell in this instrument. Then, use the procedure in the Mettler book you have.

LINEARITY

Located just in front of the Calibration pot is a circuit board. This board has two pots with shafts oriented in the same direction as the cal. pot (however, these are smaller pots) The linearity pot is the TOP one.

Installation of PML4 Linearity Board / Mettler

The PML4 board is an add-in board, which gives PM and PJ instruments a linearity potentiometer. This board fits in instruments with chassis size of approximately 12" x 8". Linearity adjustment is often required after replacement of a front coupling. *No electronic adjustment or circuit can compensate a damaged cell, or one which has been assembled incorrectly.* To successfully install the PML4, you'll **need excellent soldering and desoldering skill. Without that skill, there is a risk of damaging the main board.**

1) Take anti-static precautions. Work on a static-dissipating workbench, or wear an anti-static bracelet. See the anti-static precautions on the following page.

2) Remove the instrument cover (one screw) , then remove any shroud which covers the cell. Some instruments won't have a shroud. If a data-interface board is mounted on the right side of the instrument, remove it (one screw). Release the display board from the plastic clips which secure it, then unplug connector #1. Set the display aside (careful, VERY expensive), then unplug the remaining three connectors. Remove the three screws, then remove the entire main board from the instrument chassis.

3) Locate IC13. Remove it by clipping all 8 pins at the IC body, then de-soldering each lead from the board. Remove the solder from the holes vacated by the IC pins. The holes must be clear to receive the PML4 board. Place the 8 pins of the PML4 into the 8 holes vacated by IC-13. When properly oriented, the potentiometer adjustment will be accessible from the edge of the board, and the bare wire will point forward. The underside of the PML4 will rest against the top of a rectangular capacitor on the main board. Solder all 8 connections.

(Continued next page)

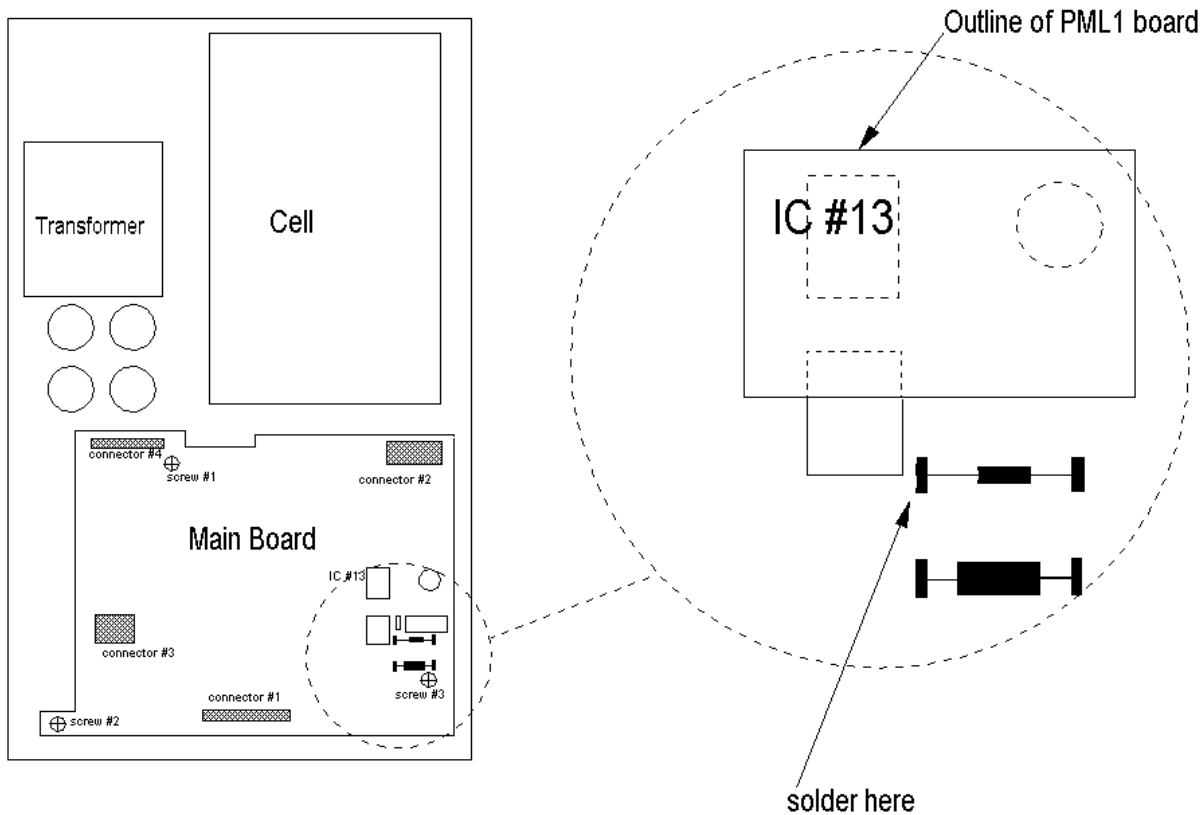

Locate the CALIBRATION RESISTORS, just in front of the PML4. They are soldered onto metal posts, just in front of the board you are installing. Bend the bare wire to the inner stake of the front resistor, then solder. Remove any excess wire. Re-install the main board, with 3 screws. Connect all cables. Install display board. Put on the pan and power up.

4) The potentiometer on the PML4 board can now be used to adjust linearity. It has an adjustment range of about 10 counts. Adjusting linearity will effect calibration, so re-calibrate after adjusting linearity. If the range of adjustment of the pot is inadequate, then close the solder bridge on the PML4. This will roughly double it's range of adjustment.

Static Electricity

Static electricity can easily ruin an electronic circuit, especially modern CMOS ICs and microprocessors. For that reason, you need to control static charge on anything that touches the circuit board, especially yourself.

Your workbench should be made of a static dissipating material , such as wood, NOT Formica or plastic laminate. You can bleed static charges away by connecting the third wire of a power outlet (green conductor) to the frame of the bench. You should have a metal object, also grounded, which can be used to discharge yourself. Touch ground before you work on circuit boards. The best solution is to wear an anti-static wrist strap, which connects you to ground constantly.

Installation of PML1 in High Capacity Instruments / Mettler

The Problem

The PML1 board was designed to fit PM/PJ top-loaders. It can't be installed DIRECTLY into a high-capacity instrument such as PM-30, because Mettler uses a different section of the LM358 IC for the integrator in the high capacity instruments

The Cure

1

If you're not a skilled electronic technician, you probably shouldn't try this.

2

Several main boards exist for the large PMs, and not all are documented by Mettler. You'll need to find the integrator (LM358), and determine where on the instrument you will mount the linearity board. You are LIKELY to find the integrator just to the left of the large pink capacitors, pin 1.

3

Remove the LM358, and the 8 gold pins, from the linearity board, since you won't be removing the 358 from the main board. Use ribbon cable to connect pins 1, 4, and 8 of the instrument's LM358 to the position on the linearity board where the LM358 was removed.

4

On the PML1, locate pin 7 of the LM358, and the trace which exits pin 7 toward a 1M resistor. Remove a very short piece of the trace, between pin 7 and the 1M.

Using a 1/2" length of insulating sleeve, and about 1" of small bare wire (#30 is great), connect the previously disconnected end of the 1M to pin 1 of the LM358.

5

Connect the bare wire from the linearity board to the un-grounded end of the instrument's calibration resistor.

6

You may want to remove the 200K pot from the underside of the board and re-mount it on the top side. The hole alignment of the pins on the pot won't be perfect, but it will be functional.

7







An optional step is to replace the 1M resistor along-side the pot (not the 1M mentioned earlier !!) with a 100K, and to close the solder bridge. This will increase the adjustment sensitivity, and may be necessary on some instruments.

XS Calibration Configuration - Mettler

You can download the entire XS User Manual from <http://us.mt.com/home> , then select “Laboratory Weighing”, then “Services and Support” , then “Download Center”.

The panel has two types of keys/buttons: printed buttons on a metallic background with fixed function, and “icon” keys formed on the display screen.

Fixed-Function Keys

Key Symbol	Key Name	Description
	Go to Application	Return to application program
	Re-zero	Reset zero and tare memories to zero
	Application select	Select from application programs
	Tare	Reset tare memory to zero
	Configure Application	Adjust application program settings
	Transmit	Transmit data to printer, computer, or other device

Icon Keys Icon Keys appear on the screen with a descriptive phase which suggests the function.

1. Enabling internal or external calibration

The instrument can be configured to accept either internal calibration and adjustment (C&A), or external C&A, or either/both. Only the C&A modes which are enabled will show an icon on the screen in weighing mode. To enable or disable either mode, proceed as follows:

Action	Result
Press  key	First of four configuration menus appears . (don't scroll to other menus)
Press “Define” to the right of “Function Keys”	First of two sub-menus appears (don't scroll to other menus)
Press the box to the right of either “Adjust int.” or “Adjust ext.”	corresponding adjustment enabled/disabled
Press “OK” twice	instrument returns to normal weighing mode

continued next page

XS Calibration, Internal, External - Mettler

2. Enable/disable “ProFACT”

ProFACT is the automated recalibration of the instrument either periodically, or after sensing a temperature change. It is desirable because it compensates for temperature changes. It is undesirable because it continually wears the calibration system, and because it may overwrite any external calibration. When calibration adjustment to an external standard is mandatory, ProFACT either needs to be turned OFF, or configured so that it prompts the user for an external calibration weight.

To enable or disable ProFACT:

Action	Result
Press ■■■■	Application menus show on screen
Press “System” icon key	System menus show on screen
Press “Adjust/Test” icon key	Current Adjust/Test configuration shows
Press the box to the right of “FACT”	Sub-menu shows
Press desired choice Press “OK”	
Press 	Normal weighing mode resumes

Calibration Adjustment - Internal

Action	Result
Press “Adjust Int.”	Calibration adjustment sequence starts Do not place anything on the weighing pan Wait for “ Adjustment done” on screen
Press “OK”	Instrument returns to weighing mode

Calibration Adjustment – External

Action	Result
press “Adjust ext.”	screen prompts for external calibration weight
Place indicated weight value on pan	screen indicates “please wait” screen prompts to remove calibration weights
Remove weights from pan	screen indicates “please wait” screen indicates “Adjustment done”

Press “OK” instrument returns to weighing mode

XS Enter corrected value for external calibration weight

If you are using an external calibration weight and you have a calibration certificate for your weight, you can enter the corrected value. For example, an ASTM class 1 200 gram calibration weight can be anywhere from 199.9995 gram to 200.0005 gram and still be within class1 specification, but will introduce an error of up to 5 graduation on a 4-place analytical balance. But a calibration certificate will allow the technician to enter the corrected value of the weight (for example, 200.0003). And so, there will be no error introduced into the weighing results due to the calibration weight not being perfectly accurate.

Enter external weight actual value

Action	Result
Press ■■■■	Applications Menu show
Press “System”	System Menu shows
Press “Adjust/Test”	Screen shows: Fact On or Off Adjustweight value Testweight value
Press the Adjustweight value	Adjustweight screen shows Weight value ID (may be blank) Certificate # (may be blank)
Press on the Adjustweight value	numeric keypad appears on screen
Enter actual weight with decimal (example: 200.0003) press “OK”	Screen shows corrected weight value
Press OK	Adjust/Test screen shows
Press OK	Menu select screen shows
Press “Exit”	Instrument returns to weighing mode







If you are working on 4 or 5 place analytical balances AND you don't have a calibration certificate in order to correct your weight, then you will probably get a more accurate calibration by using the internal calibration weight. The internal calibration weights are more accurate than ASTM class 1.

XP Calibration Configuration - Mettler

You can download the entire XP User Manual from <http://us.mt.com/home> , then select “Laboratory Weighing”, then “Services and Support” , then “Download Center”.

The panel has two types of keys/buttons: printed buttons on a metallic background with fixed function, and “icon” keys formed on the display screen.

Fixed-Function Keys

Key Symbol	Key Name	Description
	Go to Application	Return to application program
	Re-zero	Reset zero and tare memories to zero
	Application select	Select from application programs
	Tare	Reset tare memory to zero
	Configure Application	Adjust application program settings
	Transmit	Transmit data to printer, computer, or other device

Icon Keys Icon Keys appear on the screen with a descriptive phase which suggests the function.

1. Enabling internal or external calibration

The instrument can be configured to accept either internal calibration and adjustment (C&A), or external C&A, or either/both. Only the C&A modes which are enabled will show an icon on the screen in weighing mode. To enable or disable either mode, proceed as follows:

Action	Result
Press  key	First of four configuration menus appears . (don't scroll to other menus)
Press “Define” to the right of “Function Keys”	First of two sub-menus appears (don't scroll to other menus)
Press the box to the right of either “Adjust int.” or “Adjust ext.”	corresponding adjustment enabled/disabled
Press “OK” twice	instrument returns to normal weighing mode

continued next page

XP Calibration, Internal, External - Mettler

2. Enable/disable “ProFACT”

ProFACT is the automated recalibration of the instrument either periodically, or after sensing a temperature change. It is desirable because it compensates for temperature changes. It is undesirable because it continually wears the calibration system, and because it may overwrite any external calibration. When calibration adjustment to an external standard is mandatory, ProFACT either needs to be turned OFF, or configured so that it prompts the user for an external calibration weight.

To enable or disable ProFACT:

Action	Result
Press ■■■■	Application menus show on screen
Press “System” icon key	System menus show on screen
Press “Adjust/Test” icon key	Current Adjust/Test configuration shows
Press the box to the right of “FACT”	Sub-menu shows
Press desired choice Press “OK”	
Press 	Normal weighing mode resumes

Calibration Adjustment - Internal

Action	Result
Press “Adjust Int.”	Calibration adjustment sequence starts Do not place anything on the weighing pan Wait for “ Adjustment done” on screen
Press “OK”	Instrument returns to weighing mode

Calibration Adjustment – External

Action	Result
press “Adjust ext.”	screen prompts for external calibration weight
Place indicated weight value on pan	screen indicates “please wait” screen prompts to remove calibration weights
Remove weights from pan	screen indicates “please wait” screen indicates “Adjustment done”

Press "OK"

instrument returns to weighing mode

XP Enter corrected value for external calibration weight

If you are using an external calibration weight and you have a calibration certificate for your weight, you can enter the corrected value. For example, an ASTM class 1 200 gram calibration weight can be anywhere from 199.9995 gram to 200.0005 gram and still be within class1 specification, but will introduce an error of up to 5 graduation on a 4-place analytical balance. But a calibration certificate will allow the technician to enter the corrected value of the weight (for example, 200.0003). And so, there will be no error introduced into the weighing results due to the calibration weight not being perfectly accurate.

Enter external weight actual value

Action	Result
Press ■■■■	Applications Menu show
Press "System"	System Menu shows
Press "Adjust/Test"	Screen shows: Fact On or Off Adjustweight value Testweight value
Press the Adjustweight value	Adjustweight screen shows Weight value ID (may be blank) Certificate # (may be blank)
Press on the Adjustweight value	numeric keypad appears on screen
Enter actual weight with decimal (example: 200.0003) press "OK"	Screen shows corrected weight value
Press OK	Adjust/Test screen shows
Press OK	Menu select screen shows
Press "Exit"	Instrument returns to weighing mode

If you are working on 4 or 5 place analytical balances AND you don't have a calibration certificate in order to correct your weight, then you will probably get a more accurate calibration by using the internal calibration weight. The internal calibration weights are more accurate than ASTM class 1.

Flexible parts pictures – for Mettler

SM low capacity 504184HCC

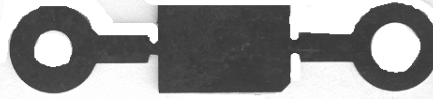

PM inner 504184HCC2



SM high capacity coupling 504184HCC3

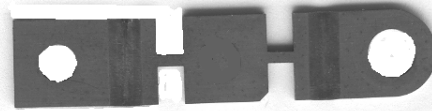

PM low capacity outer 504184HCC4

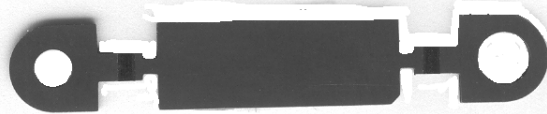

PM High capacity outer 504184 HCC5

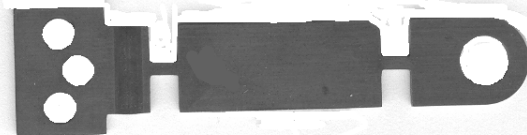

PM/SM inner levers 504184vfb

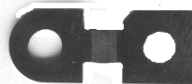

Option 012 Circuit Board - Mettler

The Mettler 012 interface board connects the Mettler AE series of instruments with an external RS-232 device, such as a computer. In order to function successfully, the communications parameters set at the computer and those set at the 012 board must match.

Change the BAUD RATE on the 012 circuit board using the movable jumpers. Select a baud rate identical to that of the computer.

Jumper	1	4800
	2	2400
	3	1200
	4	600
	5	300

Adjust switches 1 through 4 to adjust communications parameters:

Switch 1	Parity ON/OFF
2	Parity ODD/SPACE
3	not used
4	Flow CONTINUOUS / NOT CONTINUOUS

OHAUS

AP and AS Calibration

AP Calibration (Span):

- 1 Pan empty and unit turned on. You MUST have an accurate calibration weight, with known error, prior to external calibration:

AP110	100g	
AP210, 250		200g
AP310		300g
- 2 Press and hold ON/TARE until "CAL" shows, then release.
- 3 Press MODE repeatedly until "USr" shows.
- 4 Press ON/TARE (value of previous external calibration weight shows).
- 5 Press MODE to change the value of the flashing digit, or ON/TARE to move to another digit.
- 6 After all digits have been entered or accepted, "CAL 0" will show. Press ON/TARE.
- 7 The display will show " CAL - - - - ", then " CAL # # # # # # "
- 8 Press ON/TARE. The unit will show " - - - - CAL " then return to normal operation.

Linearity: To do linearity adjustment, buy the Ohaus Service manual, and use the software that is supplied with the manual.

AS Calibration (Span)

1. Press and hold the ON / →OT← button until CAL shows, then release.
(display goes to " SPAN ")
2. Press and release ON / →OT← (display shows " C 0g ")
3. Press and release ON / →OT← (display shows " C " , then a weight value)
4. Place the indicated weight value on the pan. then press ON / →OT←
5. The display will show " -C- "
6. When the display shows the weight value with unit of measure, the instrument has been calibrated and has returned to weighing mode.

B-1500A -- Calibration / Ohaus

1

The B-1500 A has two calibration (span) adjustments. The COARSE adjustment is done with switches on the display board. The chart below details the calibration range available from various switch settings.

2

FINE adjust is located on the REAR PANEL, towards the top. Due to the range of adjustment available, it is normally the only calibration adjustment needed. It is not necessary to open the instrument to adjust this calibration pot, the slotted shaft is accessible from the exterior.

3

Below are various switch setting and the range of calibration values available from each switch setting for full CW and CCW rotation of the calibration pot. Readings were taken with a 1Kg weight. Readings will be slightly different throughout the US.

0=OFF (open)

1=ON (closed)

Calibration Potentiometer

12345	Clockwise	C Clockwise
11010	1024.3	1012.0
00110	1016.8	1004.6
10110	1009.3	997.1
01110	1001.8	989.7
11110	994.2	982.3

B3000 -- Calibration and Linearity / Ohaus

Like other Ohaus B series balances, the B3000 has both a coarse and a fine calibration adjustment. Normally, only the fine adjustment potentiometer is required. In situations where the calibration can not be set accurately with the fine potentiometer, the coarse calibration switches must be reset.

The fine adjustment pot is located on the front panel, above the TARE bar.

The coarse adjustment switches are located inside the instrument, on the readout PC board. Unplug the power cord before removing the instrument's cover. Notice that the series of six switches is labeled 1 through 6. Only switches 1-5 effect calibration. Switch 1 (left most) makes the least effect on calibration, switch 5 the most. Opening a switch will make the instrument read a higher number than with the same switch closed. The chart below indicates the approximate amount of calibration shift which each switch will make on calibration, when checking with a 3000 gram test weight.

Switch #	Digits
1	150
2	300
3	600
4	1200
5	2400

When checking calibration with a test weight other than 3000 grams, the calibration shift caused by each switch will be effected proportionally. For example, switch #1 will make approximately 50 digits of calibration shift when tested with a 1000 gram weight.

Since adjustment of the coarse calibration is normally necessary only when electronic repairs are made, the need for their adjustment under other circumstances suggests an electronic malfunction.

Linearity

Mounted on the cell is a small circuit board containing, among other things, a potentiometer. That potentiometer is the linearity adjustment.

E Series -- Calibration and Linearity / Ohaus

Ohaus's E series instruments (E3000D, etc.) are calibrated from the front panel. Neither sensitivity (span) nor linearity require removal of the instrument cover.

The following instructions pertain to E3000. Other E series instruments (different capacity) will require different calibration weights.

Calibration

- 1 Turn the instrument ON.
- 2 Push and hold the ON button until - CAL - is seen on the display, then release the ON/TARE button.
- 3 After C 0g is displayed, wait several seconds, then press and release the ON/TARE button.
- 4 After C2000g is displayed, place 2000 grams on the pan, wait several seconds, then press and release the ON/TARE button.
- 5 Span (sensitivity) has now been adjusted.

Linearity

1 This procedure is very similar to the above one, but instead of starting with the instrument ON, UNPLUG it! Press and hold the ON/TARE, then plug back in. The instrument will go into a calibration routine similar to that above, but with intermediate weight values prompted by the instrument's display

G and GT Series -- Linearity and Calibration / Ohaus

The Ohaus G and GT instrument use a series of slide switches on the main board to enable/disable the linearity correction feature. When enabled, the SPAN adjustment will call for intermediate weights, and make corrections for linearity automatically. There is no linearity pot.

Before changing the position of the switch that enables this capability, UNPLUG the instrument.

	G Series	GT Series
Linearity ON	switch 8 ON	switch 4 OFF
Linearity OFF	switch 8 OFF	switch 4 ON

Adjustment:

1

Press and hold TARE until CAL appears on the display

2

Display will show C 0 Allow the instrument several seconds to stabilize, then press and release the ZERO button.

3

Display will show C xxx Place the indicated weight (xxx grams) on the pan, allow for stabilization, then press and release ZERO.

4

Display will show C zzz Place the indicated weight (zzz grams) on the pan, allow for stabilization, then press ZERO.

The instrument will return to standard operating mode, span and linearity have been adjusted.

Recommended Check !!

Because the microprocessor forces the readings to be correct at full scale and the intermediate reading (xxx in the procedure above), the readings at those weights will always be correct. However, that doesn't mean the linearity is good throughout the weighing range. Verify that the linearity is good at weights other than those used in the adjustment procedure.

If linearity is poor, measuring cell damage is indicated.

Galaxy G160 and G110 -- Calibration / Ohaus

These are the analytical balances from Ohaus, with glass doors. The calibration of these "Galaxy" balances is different from the top-loader "Galaxy" types.

Calibration - internal

1

Warm up until stable, tare to zero.

2

Using extreme care to avoid disturbing the instrument stability, rotate the calibration lever (right side) until the display shows "C". See the note below if "CE" appears.

3

When "CC" appears on the display, calibration is complete. Return the lever to the original position.

Calibration - external

1

Warm up until stable. Locate and remove the upper hole plug on the left side, toward the rear. Tare.

2

Using extreme care to avoid disturbing the instrument stability, depress the flat metal plate located in the hole. (You may need a pointed object to reach into the hole, like a ball-point pen.) The display will indicate "C". See the note below if CE appears.

3

Place a 100 gram weight on the pan, wait for a indication of 100.0000 on the display and a "beep".

4

Remove the weight, replace the hole plug. The unit is now in the normal operating mode.

If "CE" appears, then try the procedure again, starting from all zeros, and paying careful attention to stability. If it's impossible to complete the procedure, then repair is needed.

Ohaus will send you an operators instruction booklet at no charge. Give them a call at 1-800-526-0659.

TS & TP -- Calibration / Ohaus

General:

The instrument has four menus (CAL, User, Setup, and Print) internally. To get into the menu system, press and hold ON/TARE until the first menu (CAL) appears. Jump from menu to menu, or make selections within a menu, by pressing MODE. Make a selection by pressing ON/TARE.

Calibration:

Action	Display
1. Pan empty, plugged in , push "OFF"	blank
2. Press and hold ON/TARE button until "CAL"	CAL
3. release ON/TARE	SPAn
4. Press OFF/MODE	Lin
5. Press ON/TARE	C 0g
6. Press ON/TARE	C, then C # # # g
7. Place the indicated weight on the pan, then press ON/TARE	C, then C # # # g
8. Place the indicated weight on the pan	# # # g
9. Press ON/TARE	balance will calculate Linearity and revert to weighing mode.

If access to the CAL menu is not possible, then it probably has been locked out. To re-enable calibration, enter the SETUP menu, jump to LOCK SWITCH, then unlock the CAL function.

Notice regarding repairs

These instruments have operating parameters stored in an on-board memory (EEROM). If the instrument becomes nonfunctional, repair will not be possible by swapping boards or installing a new board, since the data in the EEROM will be absent from the new board. Send non-functional instruments to IES for repair.

Explorer Calibration - Ohaus

Internal Calibration

1. Not all models are equipped with internal cal .This function will not be available in that case.
2. Press SETUP, CAL will be displayed , press ENTER to select
4. CAL TYPE is displayed, select with ENTER
5. InCAL is displayed, press ENTER
6. The internal calibration continues automatically. After the internal mechanism moves the internal weight several times, the display will show CAL SET, and then return automatically to the normal weighing mode.

External Calibration (to an external weight)

1. This procedure calibrates the instrument to an external weight standard.
2. Press SETUP, CAL will be displayed , press ENTER to select
3. CAL TYPE is displayed, select with ENTER.
4. Using the up and down arrows, scroll to USER, then select with ENTER.
5. The value of calibration weight is adjustable using the arrow keys. Use the right/left arrows to select digits, and the up/down arrows to change the digit. The resultant number must be at least 25% of the weighing capacity. After specifying the complete weight value using the arrow keys, finalize by pressing ENTER.
6. The display will direct you to place the indicated weight value on the pan, then press ENTER.
7. When the instrument returns to normal operation, external calibration has been completed.

NOTE: If ' ERROR 3.0 ' is displayed , go through the calibration procedure again, this time wait a few seconds after you place the weight on the scale before pressing enter.

continued next page

Adjustment of the Internal weight

1. Perform the internal calibration procedure above.
2. Press O/T , the display goes to zeros.
3. Place the Span Calibration Mass on the pan

capacity	Span Mass
62	50
110	100
162	150
210	200
410	400
610	500
1550	1500
2100	2 Kg
4100	4 Kg
6100	5 Kg
8100	8 Kg

4. Write down indicated value on the display.
5. Press SETUP, CAL is displayed. Press ENTER, CAL TYP is displayed.
6. Press > until CAL ADJ is displayed, then press ENTER.
7. The current adjustment number is displayed. Press the up or down arrows until the desired deviation (from step 4) is displayed, then press ENTER . Saved will show briefly, then LOCK.
8. Press ENTER. The LOCK status shows. Change if required, then press ENTER. SAVED shows, then EXIT. (LOCK ON is for legal-for-trade applications)
9. Press ENTER, the unit returns to normal weighing mode.

Linearity

1. Press SETUP, the display shows CAL, press ENTER.
2. CAL TYP is displayed, press ENTER.
3. Use the up/down arrows to select LIN, then press ENTER.
4. BUSY or WORKING is displayed, then PUT WT #####. Place the specified ##### weight on the pan, then press ENTER.
5. BUSY or WORKING is displayed, then another number #####
6. Place the ##### weight on the pan., then press ENTER.
7. BUSY or WORKING is displayed, then CAL SET is displayed. The instrument returns to normal weighing mode automatically.

Navigator Calibration - Ohaus

Internal Calibration

- 1 Not all models are equipped with internal cal .This function will not be available in that case.
2. The AC adapter must be connected and in use.
3. Press SETUP, CAL will be displayed , press ENTER to select
4. CAL TYPe is displayed, select with ENTER
5. InCAL is displayed, press ENTER
6. The internal calibration continues automatically. After the internal mechanism moves the internal weight several times, the display will show CAL SET, and then return automatically to the normal weighing mode.

External Calibration (User Cal)

1. This procedure calibrates the instrument to an external weight standard.
2. Press SETUP, CAL will be displayed , press ENTER to select
3. CAL TYPe is displayed, select with ENTER.
4. Using the up and down arrows, scroll to USER, then select with ENTER.
5. The value of calibration weight is adjustable using the arrow keys. Use the right/left arrows to select digits, and the up/down arrows to change the digit. The resultant number must be at least 50% of the weighing capacity. After specifying the complete weight value using the arrow keys, finalize by pressing ENTER.
6. The display will direct you to place the indicated weight value on the pan, then press ENTER.
7. When the instrument returns to normal operation, external calibration has been completed.

NOTE:

Experience shows that the procedure is sensitive to the speed at which the operations are performed. If 'ERROR 3.0 ' is displayed , go through the calibration procedure again, this time wait a few seconds after you place the weight on the scale before pressing enter. If you still get ERROR3.0 , try waiting 15 or more seconds.

Adjustment of the Internal weight

1. Perform the internal calibration procedure above.
2. Press O/T , the display goes to zeros.
3. Place the Span Calibration Mass on the pan

capacity	Span Mass
32	30
210	200
410	400
810	800
2100	2 Kg
4100	4 Kg
8100	8 Kg
4. Press ENTER . Write down indicated value on the display.
5. Press SETUP, CAL is displayed. Press ENTER, CAL TYP is displayed.
6. Press > until CAL ADJ is displayed, then press ENTER.
7. The current adjustment number is displayed. Press the up or down arrows until the desired deviation (from step 4) is displayed, then press ENTER . Saved will show briefly, then LOCK.
8. Press ENTER. The LOCK status shows. Change if required, then press ENTER. SAVED shows, then EXIT.
9. Press ENTER, the unit returns to normal weighing mode.

Linearity

1. Press SETUP, the display shows CAL, press ENTER.
2. CAL TYP is displayed, press ENTER.
3. Use the up/down arrows to select LINEARITY, then press ENTER.
4. BUSY is displayed, then PUT WT #####. Place the specified ##### weight on the pan, then press ENTER.
5. BUSY is displayed, then another number #####
6. Place the ##### weight on the pan., then press ENTER.
7. The instrument returns to normal weighing mode automatically.

Voyager Calibration - Ohaus

The Voyager line has several calibration options, and not all options are present in all models. Determine first whether the instrument being calibrated has an internal calibration weight by trying an internal calibration.

Internal Calibration

1. Press ENTER. The menu is displayed.
2. Use the up and down arrows (^ and v) to scroll to CALIBRATION , press ENTER.
3. Use ^ and v to scroll to AUTOCAL, then press ENTER
If AUTOCAL is not a choice, then the instrument does not have an internal calibration weight. See "External Calibration, below . If AUTOCAL does show, then the instrument completes the internal calibration cycle without further operator input.

External Calibration (User Calibration)

1. Press ENTER to display the menu, scroll to CALIBRATION using ^ and v , then press ENTER
2. Scroll to USER , then ENTER. Select the desired calibration weight using the > and < keys.
3. Follow the instructions on the display to complete the external calibration process.

Internal Weight correction (adjustment of the internal weight)

1. Place a calibration weight on the pan

Capacity	Cal. Weight
62	50 g
110	100
210	200
410	400
610	500
2100	2 Kg
4100	4
6100	5
8100	8

2. Note the difference between the indicated value and the actual value of the weight.
(Special: if the difference exceeds 100 digits, then the instrument is in need of repair)
3. Press Enter, scroll to CALIBRATION, then press ENTER .
4. Scroll to AUTUCAL DELTA CORRECTION
5. Use the arrow keys to select the number determined at step 2. Press ENTER
6. Follow the instructions on the display.

Linearity

1. Press ENTER, scroll to CALIBRATION, press ENTER
2. Scroll to LINEARITY, press ENTER.
2. Follow instruction on the display.

PERKIN-ELMER

AD4 Microbalance -- Calibration / Perkin-Elmer

Background :

When the instrument is first powered up, the instrument will go into the calibration mode automatically. The normal weighing pans should be in place. Obtain a complete set of operating instructions from Perkin-Elmer (phone 800-762-4002) under PE part number C 099-1271. Calibrate as follows:

1

Press " AUTOTARE "

The weight indication (right display) will be blank initially, then digits will appear sequentially. (If the weight indication is all dashes, then go to step B below.) After the number has completed all digits, it goes blank, then goes to all minus signs. Range (indicated on left display) changes to 200 mg automatically.

2

Place a 100 mg weight on the sample pan. Right display maintains minus signs.

3

Enter weight value via keyboard (example: 100.08) Right display indicates entered number.

4

Depress " CALIB "

The instrument will automatically sequence through a stabilization, then calibration value indication, then go to normal operating mode.

5

The instrument may be calibrated any time after it is been turned on and in use. To do so, press " AUTOTARE ", then select the 200 mg range, then proceed from step 2 above.

A

If the display shows **flashes** 2.4000, 24.000, 240.00, or 1200.0 , the capacity of the current range is being exceeded.

B

If, at power-up, the TARE value exceeds the 2 mg capacity , then the display will show dashes. The likely cause of this is mismatched pans, or a pan absent from one side.

PRECISA**280 Series -- Calibration (Span) / Precisa**

Action	Readout Indication
Push and release TARE	0.00
Push and hold TARE	CAL
Release TARE	flashing 0 then flashing NUMBER
Add cal weight (NUMBER) to pan	flashing NUMBER then steady NUMBER
Calibration is complete	

The Precisa model numbering system:

Precisa (PAG of Switzerland) puts two model designations on most instruments. One is the visible number printed on the front panel, such as " 600C ". However, the serial number tag on the instrument will show a another number for the model designation, such as " 280-9430 ", plus a serial number. The front panel number indicates the capacity and resolution (600 grams by .01 gram in this case), whereas the serial number tag number indicates the "family" of electronics which are used in the particular instrument (280 in this case). Different families will use different calibration procedures.

Families that have been made: 470, 250, 270, 280, 290, 300

(PAG) 300 Series -- Linearization / Precisa

This article applies only to the 300 family of instruments. You **must** have the Precisa linearity adjustment box, which has four buttons, and plugs into the rear of the instrument.

1) Unplug the instrument power cord. Plug in the adjustment box at the rear. Locate the 9 jumpers in the front right corner of the main board. Unsolder the right-most jumper. Plug the instrument back in to power.

2) Units with one range:

- a. Power ON, no weight on pan. (Display shows a number, don't TARE it away)
- b. Press **ZERO POINT** on the adjustment box, wait for display to flash about 8 times.
- c. Put 1/2 capacity on the pan, press **1/2 CAPACITY**, wait for about 8 flashes.
- d. Put full capacity on the pan, press **FULL CAPACITY**, wait for about 8 flashes.
- e. Press **EVALUATION** on the adjustment box.
- f. Power off, then unplug from power. Unplug adjustment box; solder jumper.

Units with two weighing ranges:

- a. Power ON, no weight on pan. (Display shows a number, don't TARE it away)
- b. Press **ZERO POINT** on the adjustment box, wait for the display to flash about 8 times.
- c. Put 1/2 capacity (of small range) on the pan, press **1/2 CAPACITY**, wait for about 8 flashes.
- d. Put full capacity (of the small range) on the pan, press **FULL CAPACITY**, wait for about 8 flashes.
- e. Press **EVALUATION**. A round sign will appear on the display. Remove all weight from pan.
- f. Press **ZERO POINT** on the adjustment box, wait for the display to flash about 8 times.
- g. Put 1/2 capacity (of large range) on the pan, press **1/2 CAPACITY**, wait for about 8 flashes.
- h. Put full capacity (of the large range) on the pan, press **FULL CAPACITY**, wait for about 8 flashes.
- i. Press **EVALUATION**.
- j. Power off, then unplug from power. Unplug adjustment box, desolder jumper.

PAG puts two model designations on most instruments. One is the visible number printed on the front panel, such as " 600C ". However, the serial number tag on the instrument will show a another number for the model designation, such as " 280-9430 ", plus a serial number. The front panel number indicates the capacity and resolution (600 grams by .01 gram in this case), whereas the serial number tag number indicates the "family" of electronics which are used in the particular instrument (280 in this case). Different families will use different calibration procedures.

Families that have been made: 470, 250, 270, 280, 290, 300

SARTORIUS

Letter Series -- Software Correction of Internal Calibration Weight / Sartorius

Series A

Series E

Series H

Series I

Series L (see the separate article for LA, LP, LC)

Series R

Series U

This procedure matches the internal weight to an external standard.

Preparation: Verify that instrument is in "C" mode from menu. (not "L")

- 1 Change menu to "C331"
- 2 Switch balance off, then back on.
- 3 When you see "0.00", hold tare button until CAL value is displayed.
- 4 Place displayed value weight on pan.
- 5 Wait for beep to indicate calibration is complete.
- 6 Remove weight.
- 7 Switch balance off.
- 8 Press and hold CAL button while pressing and releasing the ON/OFF
- 9 CONTINUE HOLDING CAL after releasing ON/OFF (You will see CH4)
- 10 WHILE STILL HOLDING CAL-press tare once. (You will see CAL)
- 11 Release CAL button.
- 12 Wait for all zeros.
- 13 Push and release CAL once. (You will hear CAL motor drive)
- 14 When you hear the beep you are finished.
- 15 Re-Lock menu, if desired.

IES Corporation, 2324 SE 11th Ave, Portland, OR 97214

PHONE: **1-800-541-0852**/1-503-230-0646 FAX: 1-503-235-2535 e-mail: office@iescorp.com

B series -- Calibration & Linearity / Sartorius

Calibration

- 1
Empty pan, tare to zeroes.
- 2
Press and hold the CAL button until the display indicates a number.
- 3
Add the indicated weight to the pan.
- 4
Instrument will calibrate and return to normal operating mode automatically.

Linearity

- 1
Linearity pot is accessible from covered hole at the front left corner, very near the bottom.
Adjust linearity from zero to half scale and half to full scale, then check in quarter scale increments.

BP Calibration -Sartorius

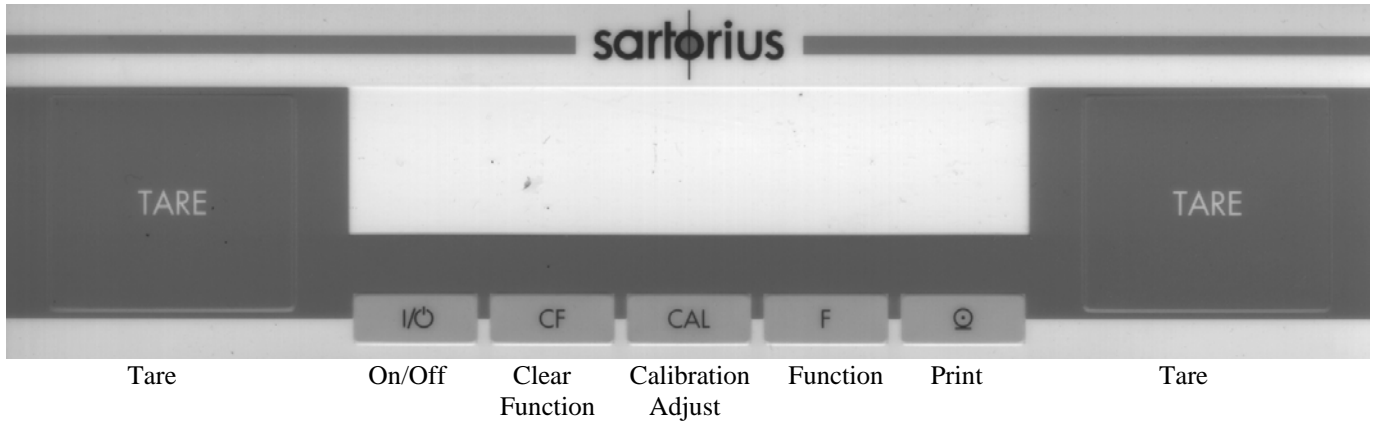

Warning:

Don't flip any switches on Sartorius balances unless you are SURE you know what the switch does. The result can be a de-programmed memory, and a functionless instrument

Introduction

There are several calibration methods available, and not all are available on every BP model. Most BP instruments do NOT have internal weights, so internal calibration is not possible on those. Whatever calibration methods are available will be selected through the menu. For standard calibration with external weight, proceed directly to **External Calibration** below. For standard calibration, using the internal weight (unit must be so equipped) , proceed directly to **Internal Calibration**. Otherwise, enter the configuration menu system to choose a calibration type, as follows

Configuration Menu

- 1 Switch the unit OFF, then ON again, with the pan empty. During the power-up sequence (all display segments showing) press TARE. (If the display shows "1", then the configuration menu has been locked. The configuration switch is located on the rear panel to the LEFT (looking from the rear) of the power connector. In order to access the menu system, this switch must be moved to the RIGHT.) DO NOT actuate the switch located to the right of the power cable connector.
- 2 Press "CAL". The left-most digit will increment each time CAL is pressed. Stop when it gets to "1" .
- 3 Press the "PRINT" key (see picture above) . The next menu digit will show. Use the CAL key to increment this digit to 9.
- 4 Press "CAL". The right-most digit is now active, increment using CAL to the desired calibration mode:
 - 191 External Calibration
 - 193 Over-write internal calibration weights
- 5 Confirm the menu selection by pressing TARE (The symbol ° signifies that this setting is activated)
- 6 Press and Hold TARE key (to save setting) until all 8's appear on display.

External Calibration Use this procedure for instruments which do not have internal weights.

1. Press CAL. The digital display shows the weight value required.
2. Place the indicated weight value on the pan.
3. Calibration completes automatically., and the instrument returns to normal weighing mode.

Internal Calibration Use this procedure to utilize the existing internal weight .

1. Press CAL. The calibration sequence completes automatically, and the instrument returns to normal operation.

Internal Calibration with Internal Weight Re-definition

1. Complete the steps listed above under Configuration. Select option 191
2. Complete the steps listed under External Calibration.
3. Complete the steps listed above under Configuration. Select option 193
4. Use the On/Off button to turn the instrument OFF
5. While holding CAL down, turn the unit ON. Release the CAL key when all the display segments show.
6. Press TARE, then press CAL.
7. Complete the steps listed above under Configuration. Select option 191.
8. Return the configuration access switch to the left (locked) position.

CP , GC series - Sartorius

Warning: On the rear panel, there are two slide switches. One locks or unlocks the menu access, the other enables BPI mode. Enabling BPI will disable the instrument until it can be re-programmed with the Sartorius software. Unless you are certain that you need to move these switches, DON'T !!

Calibration: In order to adjust calibration, press CAL.

On instruments with built-in calibration weights AND which have not been configured via the menu to non-standard calibration settings, the internal motor will apply the internal weight to the mechanism and update the calibration adjustment. The completion of the sequence is signaled by CC on the readout.

Instruments with internal calibration weights:

CP2P , CP225D , CP324S , CP224S , CP 64 , GC1603P , GC803S , GC803P

On instruments that do not have internal calibration weights AND which have not been configured via the menu to non-standard settings, the instrument will indicate the required calibration weight on the readout. When CC is indicated, the calibration adjustment is complete.

If the above sequence does not occur, then either the menu has been set to non-standard settings, or there is a malfunction. Consult the user manual for instructions on setting the menu.

Linearity

Linearity is *adjustable* only using Sartorius proprietary software. *Check* linearity using the procedures outlined previously in this book (see Table of Contents (TOC) / General Technical Articles / Linearity) . If the procedure reveals unacceptable errors, repairs are indicated.

Cornerload

Generally, it is recommended that cornerload not be adjusted in the field. The reason is that many different cells exist, with different procedures for each. See various articles in the TOC/General technical Articles section , but proceed with extreme caution. It is possible to ruin a cell (multi-thousand \$) with a few misguided stokes of a file. Some force-restoration type cells are adjustable with conventional methods for those types of cells.

EA and EB Calibration Adjustment -

Sartorius

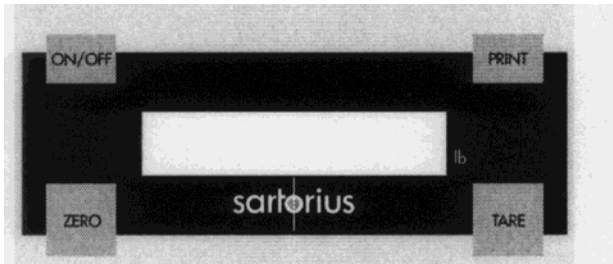

EA

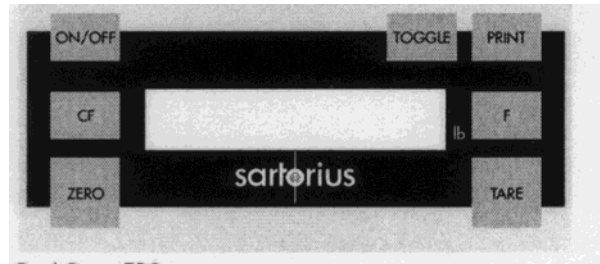

EB

Warning

Many Sartorius instruments can be disabled by flipping a single switch. Do not experiment with internal switches or switches other than those on the keypad.

Introduction

Various operational characteristics, including calibration details, are set using the menu system. In order to change the operating characteristics, the instrument will need to be changed from the normal operating mode to the menu mode, then the menu parameters changed, then returned to the normal operating mode. These steps are accomplished using the keypad shown above. Most instruments will have the menu preset to prevent external calibration (code 152), so the first step will be to enable span adjustment.

code 151 – span calibration possible

code 152 – span calibration blocked

1. Press ON/OFF to turn the unit OFF.
 2. Press ON/OFF to turn the unit ON. During the power-up display check (all segments enabled), press TARE briefly.
 3. Press TARE repeatedly until a 1 shows at the left-most digit on the display. Then press PRINT.
 4. A second digit will now be showing. Press TARE repeatedly until 15 shows, then press PRINT.
 5. A third digit will now be showing. Press TARE repeatedly until 151 shows. Press and hold PRINT until 0 shows, indicating that this code is now enabled.
 6. Press and hold TARE until the display changes, thus indicating that the new menu setting is effective.
- Note: If it is desired to leave the menu setting procedure at step 6 without making the changes effective, press ON/OFF briefly.

Calibration (Span)

need clarification/experimentation here – manual is unclear. Seems to be same as QC

Need to know what button to push. (User manual says push the TARE button, but if that starts the calibration, how do you TARE the instrument?)

Are the code numbers above correct? The user manual says 151/152, the service manual says 191/19x.

FC Calibration Adjustment - internal -**Sartorius**

Sartorius defines the word CALIBRATION to be determination of , but NOT adjustment of, the difference between the reading and the actual value of a weight. ADJUSTMENT is the correction of the reading to match the actual value.

If you push the CAL softkey on an instrument that is in the default calibration configuration, you will have to enter choices that won't make sense without the manual. IES suggests you take time to re-configure the instrument from the factory defaults, then calibrate/adjust. You need to understand the softkeys and some of the menus to do this.

Softkeys are the light blue buttons immediately below the readout on the panel. Each softkey is marked with an upward pointing arrow Δ . The softkeys become functional within menus, and the function is indicated by a word or symbol on the LCD display readout. Some typical functions are as follows:

- ◀◀ **End SETUP** mode, return to normal mode
(*This is the double arrow softkey, NOT pushing the single arrow twice !!*)
- ▼ **Scroll** down the choices one step
- ▲ **Scroll** up the choices one step
- **Select** the current choice and reveal the next level of the menu.
- ◀ **Return** to the previous menu level
- ↵ **Set** the selected choice and terminate the current selection process

1. Configure Calibration / calibration weight source (internal, external , etc.)

Action	Result
press SETUP key	menu choices are listed
press Menu softkey	configuration choices are listed on readout
scroll to "Balance/Scale functions"	
by using ▲ or ▼ softkeys	
select "Balance/Scale functions" by pressing ➤	The BAL.FUNC menu is seen
scroll to "CAL/isoTST key function"	
select "CAL/isoTST key function" by pressing ➤	Cal/isoTST choices are shown
scroll to "Internal cal/adjustment"	
select "Internal cal/adjustment" by pressing ↵	the setting is stored in memory
press ◀◀ softkey	a previous menu level shows
press ◀◀ softkey	instrument returns to weighing mode

continued next page

- ◀◀ **End** SETUP mode, return to normal mode
(*This is the double arrow softkey, NOT pushing the single arrow twice !!*)
- ▼ **Scroll** down the choices one step
- ▲ **Scroll** up the choices one step
- **Select** the current choice and reveal the next level of the menu.
- ◀ **Return** to the previous menu level
- ↵ **Set** the selected choice and terminate the current selection process

2. Configure Calibration / sequence (auto vs. manual)

Action	Result
press SETUP key	menu choices are listed
press Menu softkey	configuration choices are listed on readout
select "Balance/Scale function"	top of selection list shows
scroll to "Cal/adjustment sequence"	
select "Cal/adjustment sequence"	choices show
scroll to "Calibrate, then auto adjust"	
Set "Calibrate, then auto adjust"	this choice is now retained in memory
End	upper level menu shows
End	instrument returns to weighing mode

3. Configure Calibration / iscoCAL (instrument self-calibration on/off)

Action	Result
press SETUP key	menu choices are listed
press Menu softkey	configuration choices are listed on readout
select "Balance/Scale function"	top of selection list shows
scroll to "isoCAL function"	
select "isoCAL function"	choices show
scroll to "OFF"	
select "OFF"	isoCAL OFF setting stored to memory
End	upper level menu shows
End	instrument returns to weighing mode

After changing to the above mentioned calibration configuration settings, the instrument automatically uses the internal calibration weight (no choices to make) , completes the calibration without intervention, and no longer self-calibrates periodically. Therefore, actually performing the calibration is a one-step process

4. Calibrate (internal)

Action	Result
press CAL softkey	instrument calibrates internally and returns to normal weighing mode upon completion.

continued, next page

Pros and Cons of Calibration Configuration settings:

IES believes that the “internal calibration/adjustment is the best setting because the internal weight is more accurate than those carried by most technicians. Further, with this setting, no choices need be made during the calibration sequence . There is ample opportunity for misunderstanding the choices.

The calibration with automatic adjustment is preferable to one that must be manually confirmed in most instances.

isoCAL is undesirable because experience shows that the calibration mechanisms of many lab balances (not specifically Sartorius) is a likely malfunction operation and is subject to wear. It is also likely to be a high-cost repair.

Another understandable calibration choice would be external calibration. The advantage here is that the calibration is referenced to a standard that is “traceable” to NIST or similar. Be sure you are using weights of suitable accuracy (better than ASTM class 1 may be required) . Also, it is imperative that isoCAL be turned OFF if calibration is referenced to an external standard, since isoCAL would overwrite any such calibration automatically .

You can download the FC user manual from the Sartorius website at <http://documents.sartonews.com>.

FC Calibration & Adjustment – external

Sartorius

External calibration is a two-step process. First perform the configuration steps to prepare for external calibration, then perform the actual calibration.

Softkeys are the light blue buttons immediately below the readout on the panel. Each softkey is marked with an upward pointing arrow Δ . The softkeys become functional within menus, and the function is indicated by a word or symbol on the LCD display readout. Some typical functions are as follows:

- ◀◀ **End** SETUP mode, return to normal mode
(*This is the double arrow softkey, NOT pushing the single arrow twice !!*)
- ▼ **Scroll** down the choices one step
- ▲ **Scroll** up the choices one step
- ▶ **Select** the current choice and reveal the next level of the menu.
- ◀ **Return** to the previous menu level
- ↵ **Set** the selected choice and terminate the current selection process

1. Configure Calibration / calibration weight source (external, user define weight)

Action	Result
press SETUP key	menu choices are listed
press Menu softkey	configuration choices are listed on readout
scroll to “Balance/Scale functions” by using ▲ or ▼ softkeys	
select “Balance/Scale functions” by pressing ▶	The BAL.FUNC menu is seen
scroll to “CAL/isoTST key function”	
select “CAL/isoTST key function” by pressing ▶	Cal/isoTST choices are shown
scroll to “External cal/adjustment w user defined weight”	
select “External cal/adjustment w user defined weight” by pressing ↵	the setting is stored in memory
press ◀◀ softkey	a previous menu level shows
press ◀◀ softkey	instrument returns to weighing mode

2. Configure Calibration / sequence (auto vs. manual)

Action	Result
press SETUP key	menu choices are listed
press Menu softkey	configuration choices are listed on readout
select “Balance/Scale function”	top of selection list shows
scroll to “Cal/adjustment sequence”	
select “Cal/adjustment sequence”	choices show
scroll to “Calibrate, then auto adjust”	
Set “Calibrate, then auto adjust”	this choice is now retained in memory
End	upper level menu shows
End	instrument returns to weighing mode

- ◀◀ **End** SETUP mode, return to normal mode
(*This is the double arrow softkey, NOT pushing the single arrow twice !!*)
- ▼ **Scroll** down the choices one step
- ▲ **Scroll** up the choices one step
- **Select** the current choice and reveal the next level of the menu.
- ◀ **Return** to the previous menu level
- ↵ **Set** the selected choice and terminate the current selection process

3. Configure Calibration / iscoCAL (instrument self-calibration on/off)

Action	Result
press SETUP key	menu choices are listed
press Menu softkey	configuration choices are listed on readout
select "Balance/Scale function"	top of selection list shows
scroll to "isoCAL function"	
select "isoCAL function"	choices show
scroll to "OFF"	
select "OFF"	isoCAL OFF setting stored to memory
End	upper level menu shows
End	instrument returns to weighing mode

After changing to the above mentioned calibration configuration settings, the instrument automatically uses external calibration weight , completes the calibration without intervention, and no longer self-calibrates periodically.

4. Define Calibration Weight

Action	Result
press SETUP key	menu choices are listed
press INPUT softkey	input menu items are shown
scroll to "Cal/adj. wt "	
enter actual value of calibration weight (example: 2000.01)	entered numbers show on readout
set value (↵)	entry point moves down one notch
end	instrument returns to weighing mode

Note: If you have a calibration certificate for your calibration weight, then you can enter the corrected value as specified on that certificate. If you do not have a certificate, then enter the nominal value of the weight. Be sure your weight is sufficiently accurate for the model your are calibrating. For some models, even ASTM class 1 weights are not adequate without correction

5. Calibrate (external)

Action	Result
press CAL softkey	instrument waits for specified external calibration weight to be applied
apply calibration weight	calibration is adjusted , instrument returns to weighing mode automatically

FC Overwrite internal weight calibration –**Sartorius**

1.

Softkeys are the light blue buttons immediately below the readout on the panel. Each softkey is marked with an upward pointing arrow Δ . The softkeys become functional within menus, and the function is indicated by a word or symbol on the LCD display readout. Some typical functions are as follows:

◀◀ End SETUP mode, return to normal mode

(This is the double arrow softkey, NOT pushing the single arrow twice !!)

▼ Scroll down the choices one step

▲ Scroll up the choices one step

➤ Select the current choice and reveal the next level of the menu.

◀ Return to the previous menu level

↵ Set the selected choice and terminate the current selection process

2 Perform External calibration as detailed on previous pages using weight shown below;

Model	wt grams
FC06 BBE-S	500
FC2 CCE-S	2,000
FC 6 CCE-H/S , FC 12 CCE-S	5,000
FCG16EDE-H , FCG34 EDE , FCG64 EDE	10,000

3. Using the number keys, enter 202122

4. Press **◀◀** . (Display shows zeros)

5. Press the S Cal softkey. The display will show S Cal

6. Press Select (**➤**) 6 times

7. Press START softkey

8. When the readout shows zeros, press CF key (not softkey)

9. The instrument returns to weighing mode, with internal weight now adjusted to match calibration of the previous external calibration adjustment.

L series -- Calibration (not the same as LC**series) / Sartorius**

Note: Some L series have internal calibration weights, some don't. Try performing and "INTERNAL CALIBRATION", to determine if the instrument has internal calibration weights. If not, then external weights are required.

Internal

- 1) Turn on and TARE. Wait for 0.00g indication.
- 2) Press "CAL"
(Internal motor operates calibration system)
- 3) Display will indicate C , then flashing C, then CC.
- 4) Display shows 0.00 Calibration is complete.

External

- 1) Turn ON and allow time for stability.
- 2) Push and hold TARE button until cal weight is displayed
- 3) Place displayed calibration weight on pan
- 4) After the audible BEEP, the calibration is complete. Remove the calibration weight.

[6/1/99]

LA Calibration Adjustment - internal (not same as L, LC, or LP) / Sartorius

Sartorius defines the word CALIBRATION to be determination of , but NOT adjustment of, the difference between the reading and the actual value of a weight. ADJUSTMENT is the correction of the reading to match the actual value.

If you push the CAL softkey on an instrument that is in the default calibration configuration, you will have to enter choices that won't make sense without the manual. IES suggests you take time to re-configure the instrument from the factory defaults, then calibrate/adjust. You need to understand the softkeys and some of the menus to do this.

Softkeys are the light blue buttons immediately below the readout on the panel. Each softkey is marked with an upward pointing arrow Δ . The softkeys become functional within menus, and the function is indicated by a word or symbol on the LCD display readout. Some typical functions are as follows:

- ◀◀ **End SETUP** mode, return to normal mode
(*This is the double arrow softkey, NOT pushing the single arrow twice !!*)
- ▼ **Scroll** down the choices one step
- ▲ **Scroll** up the choices one step
- **Select** the current choice and reveal the next level of the menu.
- ◀ **Return** to the previous menu level
- ↵ **Set** the selected choice and terminate the current selection process

1. Configure Calibration / calibration weight source (internal, external , etc.)

Action	Result
press SETUP key	menu choices are listed
press Menu softkey	configuration choices are listed on readout
scroll to "Balance/Scale functions"	
by using ▲ or ▼ softkeys	
select "Balance/Scale functions" by pressing ➤	The BAL.FUNC menu is seen
scroll to "CAL/isoTST key function"	
select "CAL/isoTST key function" by pressing ➤	Cal/isoTST choices are shown
scroll to "Internal cal/adjustment"	
select "Internal cal/adjustment" by pressing ↵	the setting is stored in memory
press ◀◀ softkey	a previous menu level shows
press ◀◀ softkey	instrument returns to weighing mode

continued next page

- ◀◀ **End** SETUP mode, return to normal mode
(*This is the double arrow softkey, NOT pushing the single arrow twice !!*)
- ▼ **Scroll** down the choices one step
- ▲ **Scroll** up the choices one step
- **Select** the current choice and reveal the next level of the menu.
- ◀ **Return** to the previous menu level
- ↵ **Set** the selected choice and terminate the current selection process

2. Configure Calibration / sequence (auto vs. manual)

Action	Result
press SETUP key	menu choices are listed
press Menu softkey	configuration choices are listed on readout
select "Balance/Scale function"	top of selection list shows
scroll to "Cal/adjustment sequence"	
select "Cal/adjustment sequence"	choices show
scroll to "Calibrate, then auto adjust"	
Set "Calibrate, then auto adjust"	this choice is now retained in memory
End	upper level menu shows
End	instrument returns to weighing mode

3. Configure Calibration / isoCAL (instrument self-calibration on/off)

Action	Result
press SETUP key	menu choices are listed
press Menu softkey	configuration choices are listed on readout
select "Balance/Scale function"	top of selection list shows
scroll to "isoCAL function"	
select "isoCAL function"	choices show
scroll to "OFF"	
select "OFF"	isoCAL OFF setting stored to memory
End	upper level menu shows
End	instrument returns to weighing mode

After changing to the above mentioned calibration configuration settings, the instrument automatically uses the internal calibration weight (no choices to make) , completes the calibration without intervention, and no longer self-calibrates periodically. Therefore, actually performing the calibration is a one-step process

4. Calibrate (internal)

Action	Result
press CAL softkey	instrument calibrates internally and returns to normal weighing mode upon completion.

continued, next page

Pros and Cons of Calibration Configuration settings:

IES believes that the “internal calibration/adjustment is the best setting because the internal weight is more accurate than those carried by most technicians. Further, with this setting, no choices need be made during the calibration sequence . There is ample opportunity for misunderstanding the choices.

The automatic calibration and adjustment is preferable to one that must be manually confirmed in most instances.

isoCAL is undesirable because experience shows that the calibration mechanisms of many lab balances (not specifically Sartorius) is a likely malfunction operation and is subject to wear. It is also likely to be a high-cost repair.

Another understandable calibration choice would be external calibration. The advantage here is that the calibration is referenced to a standard that is “traceable” to NIST or similar. Be sure you are using weights of suitable accuracy (better than ASTM class 1 may be required) . Also, it is imperative that isoCAL be turned OFF if calibration is referenced to an external standard, since isoCAL would overwrite any such calibration automatically .

You can download the LA user manual from the Sartorius website at <http://documents.sartone.com>.

LA Calibration & Adjustment – external (not L,**LC, or LP) Sartorius**

External calibration is a two-step process. First perform the configuration steps to prepare for external calibration, then perform the actual calibration.

Softkeys are the light blue buttons immediately below the readout on the panel. Each softkey is marked with an upward pointing arrow Δ . The softkeys become functional within menus, and the function is indicated by a word or symbol on the LCD display readout. Some typical functions are as follows:

- ◀◀ **End SETUP** mode, return to normal mode
(*This is the double arrow softkey, NOT pushing the single arrow twice !!*)
- ▼ **Scroll** down the choices one step
- ▲ **Scroll** up the choices one step
- ▶ **Select** the current choice and reveal the next level of the menu.
- ◀ **Return** to the previous menu level
- ↵ **Set** the selected choice and terminate the current selection process

1. Configure Calibration / calibration weight source (external, user define weight)

Action	Result
press SETUP key	menu choices are listed
press Menu softkey	configuration choices are listed on readout
scroll to “Balance/Scale functions” by using ▲ or ▼ softkeys	
select “Balance/Scale functions” by pressing ▶	The BAL.FUNC menu is seen
scroll to “CAL/isoTST key function”	
select “CAL/isoTST key function” by pressing ▶	Cal/isoTST choices are shown
scroll to “External cal/adjustment w user defined weight”	
select “External cal/adjustment w user defined weight” by pressing ↵	the setting is stored in memory
press ◀◀ softkey	a previous menu level shows
press ◀◀ softkey	instrument returns to weighing mode

2. Configure Calibration / sequence (auto vs. manual)

Action	Result
press SETUP key	menu choices are listed
press Menu softkey	configuration choices are listed on readout
select “Balance/Scale function	top of selection list shows
scroll to “Cal/adjustment sequence	
select “Cal/adjustment sequence”	choices show
scroll to “Calibrate, then auto adjust	
Set “Calibrate, then auto adjust	this choice is now retained in memory
End	upper level menu shows
End	instrument returns to weighing mode

- ◀◀ **End SETUP mode, return to normal mode**
(*This is the double arrow softkey, NOT pushing the single arrow twice !!*)
- ▼ **Scroll** down the choices one step
- ▲ **Scroll** up the choices one step
- **Select** the current choice and reveal the next level of the menu.
- ◀ **Return** to the previous menu level
- ↵ **Set** the selected choice and terminate the current selection process

3. Configure Calibration / iscoCAL (instrument self-calibration on/off)

Action	Result
press SETUP key	menu choices are listed
press Menu softkey	configuration choices are listed on readout
select "Balance/Scale function"	top of selection list shows
scroll to "isoCAL function"	
select "isoCAL function"	choices show
scroll to "OFF"	
select "OFF"	isoCAL OFF setting stored to memory
End	upper level menu shows
End	instrument returns to weighing mode

After changing to the above mentioned calibration configuration settings, the instrument automatically uses external calibration weight , completes the calibration without intervention, and no longer self-calibrates periodically.

4. Define Calibration Weight

Action	Result
press SETUP key	menu choices are listed
press INPUT softkey	input menu items are shown
scroll to "Cal/adj. wt "	
enter actual value of calibration weight (example: 2000.01)	entered numbers show on readout
set value (↵)	entry point moves down one notch
end	instrument returns to weighing mode

Note: If you have a calibration certificate for your calibration weight, then you can enter the corrected value as specified on that certificate. If you do not have a certificate, then enter the nominal value of the weight. Be sure your weight is sufficiently accurate for the model your are calibrating. For some models (LA-120 , 230 , 310, 620 , 1200 , 4200S , 6200S , 8200S) , even ASTM class 1 weights are not adequate without correction

5. Calibrate (external)

Action	Result
press CAL softkey	instrument waits for specified external calibration weight to be applied
apply calibration weight	calibration is adjusted , instrument returns to weighing mode automatically

LA Overwrite internal weight calibration –**Sartorius**

1.

Softkeys are the light blue buttons immediately below the readout on the panel. Each softkey is marked with an upward pointing arrow Δ . The softkeys become functional within menus, and the function is indicated by a word or symbol on the LCD display readout. Some typical functions are as follows:

◀◀ End SETUP mode, return to normal mode

(This is the double arrow softkey, NOT pushing the single arrow twice !!)

▼ Scroll down the choices one step

▲ Scroll up the choices one step

▶ Select the current choice and reveal the next level of the menu.

◀ Return to the previous menu level

↵ Set the selected choice and terminate the current selection process

2 Perform External calibration as detailed on previous pages using weight shown below;

Model	wt grams
LA220S, 420	200
LA620S, 620P, 820	500
LA1200S, 3200D	1000
LA2200, 2200P, 2200S, 4200, 4200P, 5200P	2,000
LA6200, 6200S, 12000, 12000S	5,000
LA16000S, 34000P, 34	10,000

3. Using the number keys, enter 202122

4. Press **◀◀**. (Display shows zeros)

5. Press the S Cal softkey. The display will show S Cal

6. Press Select (**▶**) 6 times

7. Press START softkey

8. When the readout shows zeros, press CF key (not softkey)

9. The instrument returns to weighing mode, with internal weight now adjusted to match calibration of the previous external calibration adjustment.

LA error codes – Sartorius

Many error codes indicate conditions that require repair of the instrument. The following error codes refer to circumstances that may be caused by external circumstances or mis-configuration. If the suggested cause is not found, then the instrument may need repair.

Error Code	Possible Cause
L or H , or err 54	In the case of “L” , possibly the pan or sub-pan is not correctly fitted, and the instrument has Less weight applied than the microprocessor expects to ever find. H indicates Heavy, the microprocessor is sensing a heavier weight that it should ever get. If the instrument is neither underloaded (L) nor overloaded (H) , then those indications often indicate a damaged cell, which would need repair.
err 01	The data output has been mis-configured in the menu.
err 02, 17	The instrument was calibrated with the pan not empty
err 03	Calibration was attempted with instrument unstable. Allow longer warmup, or remove cause of instability.
err 08	“Power ON zero range” data from SBI interface is out of acceptable limits
err 09	applied weight data from SBI interface is outside acceptable limits
err 11, 12	tare value out of programmable range

You can download the LA user manual from the Sartorius website at <http://documents.sartorius.com>. It contains all the error codes.

LC/AC Series (not the same as L series) -- Calibration / Sartorius**A. Calibration of instruments which DO NOT have in internal cal. weight.**

- 1
Turn instrument ON, allow warm-up
 - 2
Push and hold the TARE button until "C-E" ("E" stands for external) appears on the display.
 - 3
Push TARE . The displayed number is all zeroes.
 - 4
Push F1.
A weight will be indicated on the display. Place a test weight equal to that indicated value on the pan. After several seconds, the instrument will respond audibly, and the calibration will be complete.
-

B. Calibration of instruments which have an internal weight, using the internal weight as a reference.

- 1
Turn ON and allow warm-up.
 - 2
Push and hold the TARE bar. Release the TARE when C-I ("I" stands for internal) is displayed.
 - 3
Press F1. The calibration will be completed automatically.
-

C. Calibration of instruments which have an internal cal. weight, but calibrating to an external standard.

- 1
Turn ON and allow warm up.
- 2
Push and hold the TARE bar. Release when C-I ("I" stands for internal) is seen.
- 3
Press F2 until C-E ("E" stands for external) is displayed.
Press F1.
The display will indicate a calibration weight. Place that test weight on the pan. Calibration will proceed and conclude automatically.

MC Calibration

Basics: The F2 key is used to cycle through menu items, F1 selects the menu item showing on the display.

Calibration

1. Instrument must be stable and warmed up. Weighing pan must be empty. Tare to zero. Press F1
2. At the upper right corner of the readout, either CE or CI will show. To calibrate using the internal weight, proceed to step 3. For external calibration, proceed to step 4
3. Press F1. The display will show C as the internal calibration takes place, and returns to normal weighing mode automatically. Don't disturb the instrument while C is showing. Internal calibration is complete.
4. For external calibration, press F2 repeatedly until CE shows at the upper right corner of the display, then press F1. The display will indicate the required calibration weight value. If the instrument has a keypad AND you know the corrected value of the calibration weight, it can be entered now via the keypad.
5. After placing the external calibration weight at the center of the weighing platform, press F1 .
6. The readout will show C during calibration, then return to normal weighing automatically.

Linearization

1. Empty weighing pan. Unit must be stable and warmed up.
2. Press TARE until menu choices appear at the upper right corner of the readout.
3. press F2 repeatedly until L I shows at the corner of the readout, then press F1.
4. Push TARE
5. The display shows C until internal linearization completes , then returns to normal weighing automatically.

LC/AC Series (MC1) Overwrite Internal Cal -**Sartorius**

LC/AC Series (not the same as L series) / Sartorius

1. Slide the Menu Access switch to the "Unlocked" position.
2. Perform External Calibration. Hold Tare until "C I", press F2 for display to read "C E", press F1 to activate. Place displayed weight on pan. Wait for weighing mode. Remove weights.
3. Press On/Off to switch to Standby.
4. Press On/Off to turn back on. During full segment display press and release F2. "C I" should be displayed above the weight display, and "CAL" should be displayed next to F1.
5. Press F1 to activate the internal calibration which will actually overwrite the stored calibration value.
6. Slide the Menu Access switch to the "Locked" position.

MA30 -- Calibration / Sartorius

Operation

Auto Mode

1. Open lid.
2. Press enter (to tare).
3. Place sample on pan.
4. Wait for stability then close lid. Cycle begins automatically.
5. When cycle ends open lid and remove sample.
6. Press CF (clear function).
7. Repeat at step 2 for next sample.

Manual Mode

1. Open lid.
2. Press enter (to tare).
3. Place sample on pan.
4. Wait for stability then press Enter.
5. When cycle ends open lid and remove sample.
6. Press CF (clear function).
7. Repeat at step 2 for next sample.

Calibration

1. Power on for at least 30 minutes.
2. Remove aluminum dish from pan.
3. Press on-off to turn display off.
4. Press and hold F1 until step 8.
5. Press and release on-off.
6. During 8 check press and hold F2 & print at the same time. You will see numbers without a G.
7. Release F2 & print.
8. Release F1. You will see numbers.
9. Press F1 several times until CAL 30.000 is displayed.
10. Place 30 grams on pan.
11. When display goes blank remove weight and turn on.
12. Ready to use.

Menu System / Sartorius

Sartorius has used a menu system in many generations of instruments to allow the user to adjust the instruments operating parameters. Examples of the parameters which are user adjustable are the stability sensitivity, unit of measure selection, and RS-232 communication settings. This is also where codes are entered which will enable special application software and keypad functions (300 series menu numbers).

To change the current settings, the user must first activate the menu selection function, then make a menu change, then leave the menu function.

It is important to have the user manual for the instrument, in which the various menu settings are listed. For example, to select OUNCES as the displayed unit of measure, code C515 is desired. Without the manual, the technician has no way of knowing what the desired number will be.

For application software (PLUS, Pro ##) you will need the 300 series menu code for that software. Call Sartorius at 800 645-3108 to get the menu code for the particular software. Identify the software by the designation in the lower right corner of the numeric keypad.

You'll need to be patient, since this is a confusing sequence. Read all these instructions before trying it on an instrument.

To enter the menu system:

- 1 Start with the instrument plugged in but turned off.
- 2 While holding down the TARE, turn the instrument ON.
- 3 When the instrument stops the power-up test at a C-number, release the TARE.
(See below if "L" instead of "C" is shown)
- 4 The digit immediately to the right of the C will cycle through several numbers. Press TARE when the first digit of the desired code shows.
(Example: For code C132, press TARE while the 1 appears. Display now shows C1x)
- 5 Another digit will appear and begin cycling through the choices. Press TARE while the desired digit appears. (3 in our example; the display now shows C13x)
- 6 Another digit appears and starts cycling. Push TARE while the desired number appears.
(2 in our example, the display now show C132)
- 7 The display continues to cycle in the right-most digit. To retain the selected parameter, press TARE each time the 0 shows at the right digit. Doing so will extinguish that digit, and cause the remaining right-most digit to cycle. Again press TARE as 0 is displayed. Use this method to extinguish all three digits. The instrument will then return to normal operating mode automatically, with the new parameter in effect.

L (Locked) instead of C (Change)

These instruments have a switch which, depending upon it's setting, will lock-out access to the menu system. When so positioned, the display will behave as mentioned above, except that "L" instead of "C" will be displayed. The instrument is "Locked", and although the codes can be viewed, they can't be changed.

On most top-loader models, the switch is located beneath a small black cap along the front bottom of the instrument. On "I" series higher capacity models it is inside the small panel on the right end of the display head. Changing the switch position will "unlock" the access to the menu system. After moving the switch, turn the instrument off , then begin again from step 1 above.

Menu System (continued) / Sartorius

Sartorius Menu Parameters

Digital Filtering

C111	normal
C112	more
C113	strong *
C114	extreme

Stability Range

C121	.25 digit
C122	.5 d
C123	1 d
C124	2 d
C125	4 d
C126	8 d
C127	16 d
C128	32 d *
C129	64 d

Display

C131	last decimal ON *
C132	last decimal OFF
C133	last if stable
C134	all if stable

Tare Mode

C141	TARE anytime *
C142	TARE if stable

Auto Zero

C151	ON
C152	OFF *

External Calibration

C161	accessible
C162	locked

Internal Calibration

C171	accessible
C172	locked

Data Output

C211	ext. print command / regardless stability
C212	ext. print command only if stable *
C213	automatic, sync to display, regardless stability
C214	automatic, sync to display, only if stable

Baud Rate

C221	150 baud
C222	300 baud
C223	600 baud
C224	1200 baud *
C225	2400 baud
C226	4800 baud
C227	9600 baud

Parity

C231	mark
C232	space
C233	odd *
C234	even

Special Information

C411	Program lock OFF *
C412	Program lock ON

Weight Units

C511	g	grams
C512	kg	kilograms
C513	ct	carats
C514	lb	pounds
C515	oz	ounces
C516	ozt	troy ounces
C517	o	parts/pound

"PLUS" package programming

The article is an addendum to the article on the Sartorius menu system. The PLUS software is installed in the instrument, and various functions (density, statistics, etc.) are enabled via the menu system. The user must have the correct keypad for the function. For instruction of using these functions, consult the user guide . You can call Sartorius at 800 645-3108

Weighing only	311									
Weighing with Identification number	312									
Totaling of weights	313									
Over/Under checkweighing	314									
Mass unit conversion:										
315	316	317	318	319	321	322	323	324	325	326
g	kg	ct	lb	oz	ozt	tlh	tls	tlt	gr	dwt
Calculations by a factor	327									
Weight of Residue in percent	328									
Change/loss percent	329									
Statistics	331									
Formulation	332									
Net total	333									
Formulation with filling toward zero	334									
Counting with variable sample quantity	335									
Counting w known average piece weight	336									
Animal weighing w automatic start	337									
Animal Weighing with manual start	338									
Calculation of weight per unit area	339									

How to set the desired code:

With the balance turned off (STANDBY), push down TARE control and press ON/OFF key. Release TARE control as soon as CH5 is displayed.

If "L" is displayed, change to "C" with menu access switch (C = Change, L = List).

Press TARE control each time the desired number appears for hundreds, tens and units, respectively.

Change setting of the menu access switch. "L" is displayed.

Press TARE control when 0 appears in the display.

Example for code 3 1 4
(C = Change, L = List)

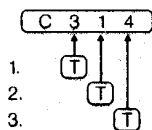

Functions common to all programs:

Store tare value:	
Enter weight or numerical value	↔
(TARE control blocked)	
Display tare value:	Info + ↔
Output tare value:	Info + Print + ↔
Print weight:	Print
I.D. no.: NUM ..	Numbers + Print
I.D. no.: K*..	Numbers + Info
Clear entry:	CE
Clear function and memory:	CF
Info function:	Info + (Print) + "x"

Menu Codes / Sartorius(older series)

This menu applies to the following older models. (14xx, 15xx,16xx,17xx, 18xx)

To enter parameter setting mode:

- 1 Turn unit OFF.
- 2 Hold TARE while turning ON, release when C shows
- 3 Numbers will cycle, press TARE when desired number shows (next digit starts cycling)
- 4 Again press TARE when desired number shows.
- 5 Retreat through menu by pressing TARE each time the last digit is a zero.

Adjust x,y, and z for parameters you desire. An "L" prefix means the menu is locked.

(unlock the menu – locate menu slide switch – flip switch)

Cx,y,z x = page

y = line

z = word

Filtration

C111 normal filtration
 112 amplified
 113 strong*
 114 extreme
 110 return to LINE

Autozero

151 ON
 152 OFF
 150 return to LINE

Data Output

211 ext print command
 without stability
 212 ext print command it
 stable
 213 auto print without
 stability
 214 auto print if stable
 210 return to LINE

Stability Range

121 .25 digit stability
 range
 122 .5
 123 1
 124 2
 125 4
 126 8
 127 16
 128 32
 129 64*
 120 return to LINE

Baud Rate

221 150 Baud
 222 300
 223 600
 224 1200
 225 2400
 226 4800
 227 9600
 220 return to LINE

Decimal control

131 ON last decimal
 132 OFF
 133 last digit only when
 stable
 134 all digits only when
 stable
 130 return to LINE

Data Parity

231 mark
 232 space
 233 odd
 234 even
 230 return to LINE

Tare

141 TARE always
 functional
 142 only if stable
 140 return to LINE

Lock

411 lock OFF
 412 lock ON
 410 return to LINE

PT1200, 600, 120, 6, QT -- Calibration /**Sartorius**

Date: Aug. 30, 1989

1. Remove cap on front right and slide switch to the left.
2. Press the OFF button.
3. Press and hold the F1 button.
4. Press and release the ON button.
5. Release the F1 button when the display shows 0.0.
6. Press and release the F1 button and place the indicated weight on the pan.
7. Slide the switch to the right and replace the cap.

QC Calibration , error codes – Sartorius

You can download the QC User Manual from the Sartorius website at <http://www.sartorius.com> , then select USA location, then select “Product Documentation”

QC Calibration

1. Start with the instrument ON until stable, nothing on the weighing pan, tare to all zeros.
2. Press TARE
3. Press and hold TARE until the display shows a plus sign and the calibration weight
4. Place the indicated weight on the weighing pan.
5. When “g” appears, calibration is complete and the instrument returns to normal operation automatically.

Model	Cal Weight
QC 5 DCE-SOUR	5,000
QC 7 DCE-SOUR	5,000
QC 7 DCE-DOUR	5,000
QC 15 DCE-SOUR	5,000
QC 35 EDE-SOUR	10,000
QC35 EDE-POUR	10,000
QC 60 FEG-SOUR	20,000
QC 65 EDE-SOUR	20,000
QC 65 EDE-DOUR	20,000
QC 150 FEG-DOUR	50,000

Error Codes

Error code	
1	display overflow
2	zero error at start of calibration, pan not empty or cell defective
3	zero error at end of calibration
10, 11, 22, 23	operator error within application program
30	unit in BPI mode / needs programming
50, 53,	electronic failure
54, 55	overload or underload. If not overloaded, possible defective cell
64	numeric entry not allow – operator error
70	wrong numeric format

QS Series Calibration & Linearity - Sartorius

Calibration

1. Turn the unit OFF by pressing the ON/OFF button.
2. While holding down the F1 key , turn the unit ON.
Release F1 once the display segments all show .
3. Tare to zero using the T key.
4. Press F1 (calibration procedure starts)
5. The display will prompt you for a weight. Add that weight to the pan.
6. After a short delay, the "+" sign will appear, along with the bar graph.
7. Remove the calibration weight. The unit returns to normal operation automatically.

Possible Problems:

If the unit will not accept calibration (step 6 above does not terminate) , then the cell may be out of range . Attempt linearization as instructed below, and then attempt calibration again. If this is not successful, send to IES for repair.

Linearization

Before adjusting linearity, determine positively that adjustment is required. DO NOT confuse linearity errors with errors which arise from inaccurate calibration.

Tolerances:

QS4000	.1 g error at any weight (+ or -)
QS8000	.2 g
QS16000	.5 g

Linearity adjustment requires the following:

- a. accurate digital ohmmeter which can measure to 20 M ohm
 - b. wide selection of 1% tolerance resistors in the range from 240K ohm to 20M ohm.
 - c. soldering skill and soldering/desoldering equipment.
1. Use the IES Linearity Chart show on page 12. Determine whether the error over the zero to half scale portion of the weighing range is higher or lower than the half to full scale portion.
 2. Desolder resistor R186 at the upper right corner of the display circuit board .
 3. Measure the desoldered resistor. Replace it with a resistor of 25% greater resistance.
 4. Again document linearity errors, taking precaution to differentiate between calibration and linearity errors.
 5. If the linearity improved, continue selecting resistors until the unit achieves performance. If the linearity worsened. then decrease the value of the linearity resistor by 20%, and again take readings. In no case should the selected value of R186 be less than 240 K ohm .
 6. Bear in mind that no amount of resistor replacing will correct the effects of a cell which has been damaged.

RC Calibration

Basics: The F1 and F2 keys serve the following functions: F2 is used to cycle through menu items, F1 selects the menu item showing on the display.

Calibration

1. Instrument must be stable and warmed up. Weighing pan must be empty. Tare to zero. Press F1
2. At the upper right corner of the readout, either CE or CI will show. To calibrate using the internal weight, proceed to step 3. For external calibration, proceed to step 4
3. Press F1. The display will show C as the internal calibration takes place, and returns to normal weighing mode automatically. Don't disturb the instrument while C is showing. Internal calibration is complete.
4. For external calibration, press F2 repeatedly until CE shows at the upper right corner of the display, then press F1. The display will indicate the required calibration weight value. If the instrument has a keypad AND you know the corrected value of the calibration weight, it can be entered now via the keypad.
5. After placing the external calibration weight at the center of the weighing platform, press F1 .
6. The readout will show C during calibration, then return to normal weighing automatically.

Linearization

1. Empty weighing pan. Unit must be stable and warmed up.
2. Press TARE until menu choices appear at the upper right corner of the readout.
3. press F2 repeatedly until L I shows at the corner of the readout, then press F1.
4. Push TARE
5. The display shows C until internal linearization completes , then returns to normal weighing automatically.

38XX Platforms -- Calibration / Sartorius

1

The calibration lever at the rear right corner actuates an internal calibration weight. When the lever is rotated 90 degree counter clockwise, the weight drops, and a micro-switch signals the microprocessor that calibration is in progress. Hold the lever in the counter-clockwise position until CC appears on the numeric display, then release the lever.

2

Verify the calibration with an external weight. If an error exists, then adjustment of the internal weight is required.

The internal weight is at the extreme rear of the instrument, at the center. It is a block of stainless steel, with several large (about 1/2" diameter) screws in it. The screws are the calibration adjustment. As the screws are adjusted in or out, the center of gravity of the weight changes, and therefore the calibration.

Adjust the calibration screws until calibration can be verified externally to be accurate.

120x -- Calibration and Linearity / Sartorius

The Sartorius 1200 series top-loaders encompass a number of units with various capacity and resolution. The construction and adjustment of all is similar, but not identical. Some models were changed during production, so some individual instruments will have more or less capacity (but close) than indicated below.

1201	1202	1203	1204	1205	1207	1209	1212	1213	1219	1264	1265	
30	400	4000	2000	200	80	600	30/300		3K/300	60/600	3000	400
.0001	.01	.1	.01	.001	.0001	.01	.001/.01	.1/.01		.001/.01	.01	.001

In order to adjust calibration, you will have to remove the top cover. It is secured by two large screws from the underside of the instrument.

WARNING These instruments use an orange plastic right-angle adjustment device on some of the pots, especially on the calibration board. They are fragile, so be careful with them. The Sartorius part number is 6937761.

SPAN - Single range types

Locate the calibration board on the right side of the instrument ; a small board mounted vertically. The potentiometer adjusts calibration. If the range of adjustment is insufficient, then locate the coarse calibration switches. These switches are accessible from the top of the main board, on the left side near the cell; a series of 6-8 DIP switches. The front switch makes the least cal change, the rear the most.

SPAN - Dual range types

Put the instrument into the coarse range, and experimentally determine which of the two pots on the calibration board effects the calibration. Adjust the coarse range first. Then put the instrument in the fine range, and adjust the other pot for span on the fine range. **NOTICE:** You must adjust the coarse range first, since the coarse range will effect the fine range, but not visa versa. Dual-range instruments have coarse-calibration switches, just like single-range types, see above.

LINEARITY

Verify that the deadload is not mis-adjusted by checking that, after TARING to all zeroes, then removing the weighing pan, the displayed number is negative. If not, adjustment of the deadload spring is required.

Most units will have a 1% precision resistor, selected at the factory, installed at position 309 on the calibration board. You can select a new resistor (use a decade box capable of adjusting to fractions of an ohm). Notice that you'll need a wide selection of low value (0-30 ohm) precision resistors. [Some instruments will have a linearity POT at R317 (1207 & 1203)]

Some units will have a linearity pot accessible from the left side of the instrument (near the bottom). IF this pot is installed, it is a linearity adjustment.

Assembly of these instruments is difficult at best. When installing a main board, be sure the screws which attach the transistors (rear of board) to the chassis (heat sink) **DO NOT** short the transistors to the aluminum chassis. Of course, the plastic insulating washer must be installed too. Be careful that cable connectors are properly installed, and black wires in the vicinity of the measuring cell are not pinched under the magnetic shield.

1364, 1303, and 1304 -- Adjustment / Sartorius

Background: Make any adjustments to the cell (feedback gain, null position, etc.) before starting this procedure. The 1303 model has 8 KG capacity, 1304 and 1364 have 4KG. 1303 does not have the extra linearity winding on the beam coil, so quarter-scale linearity adjustment is not possible.

CALIBRATE

- 1 Tare display to all zeroes. Verify calibration switch forward.
- 2 Full capacity on the pan. Move cal. switch to rear. (Display blanks)
- 3 Wait for display to flash calibration weight value, then return cal. switch to forward position

LINEARITY

1) Adjust the spring tension so that the voltage across the "gold resistor" is 0.00v with half capacity on the pan.

2) Find the linearity pot on the main circuit board (right side). Locate the 517K 1% and 100 K 1% resistors directly beside the pot, and temporarily desolder and lift one end of each.

3) On the calibration board (small piggyback board at the rear of main board), make a solder bridge across pins 12 and 13. This shorts R826 on the cal board. (Pins are numbered starting with #1 towards the front)

4) Remove R824 and R825 from the cal board. In their place, solder the leads of the decade resistor box. Set the resistor box for 20 ohms. Check linearity from 0-1/2 scale, and 1/2 to full scale, adjusting the resistor box until the two readings are equal. Remember to re-tare the balance after each decade box change. Install the indicated resistor.

5) (Skip this step for 1303 only) Remove the solder bridge that was installed in step 3. Remove R826 if it is present. Solder the leads of the R decade into the R826 position. Now observe linearity over the 0-1/4 scale and 1/4-1/2 scale range. Adjust the R decade so that the two readings are the same. Install the indicated resistor in the R826 position. It may be desirable to install a potentiometer on the back side of the calibration board in parallel with R826. Select a potentiometer of perhaps 10 times the value of R826, and increase the resistance of R826 by 20% over that indicated on the decade box.

6) Adjust the linearity pot to approximately it's center position. Resolder the end of the 517K and 100K resistors. Check linearity from 0-1/2 and 1/2 to full scale, and adjust the pot for best linearity.

7) The solder bridges on the main board may be used to offset the range of linearity adjustment provided by the pot, effectively extending the range of adjustment of the linearity pot. This won't be necessary if proper R824/825 are selected in step 4.

1400 MP8-1 -- Calibration & Linearity / Sartorius

Background:

Sartorius has produced several generations of electronic balances, with various capacities, which all use similar circuitry and microprocessors. Although the instruments from different generations are similar in appearance, they differ in circuitry and microprocessor. The specific generation can often be identified by the MP number, which will appear on the serial number plate. Calibration instructions for various models within any one MP group will be very similar. This particular article applies to the MP8-1 group.

Calibration

1

Tare to all zeroes. Environment must be stable.

2

Through the access plug on the front of the right side, press the calibration switch.
(Instrument will show " C ")

3

Apply calibration weight.
(Instrument will show flashing " C ")

4

Instrument returns to normal operating mode automatically.

Linearity

1

Unplug the instrument

2

Remove the instrument cover. Locate the 10-turn potentiometer (usually blue) on the main circuit board. It's the only 10 turn pot on the board.

3

Plug in and power on. Adjust pot for best linearity from zero to half scale and half scale to full scale. Check in quarter scale increments.

1500's -- Calibration / Sartorius

Sartorius 1501, 1507, and 1574 uses the MP8 type circuitry. Since all MP8s use basically the same digital system, they all calibrate the same way.

1

Locate the access hole on the right side, near the bottom. There is probably a small black cap over the hole.

2

To enter the SPAN calibration, press the metal plate inside the hole. The unit will show C on the display.

3

Place the calibration weight on the pan. For 1501, that's 10,000 grams. For 1507, that's 5,000 grams. For 1574, that's 4,000 grams.

4

The unit will start to flash, then display the calibration weight on the display, and then beep.

5

The unit completes the calibration cycle automatically; no more buttons to push.

One of the handy things about this series of instruments is that they indicate on the digital display the value of the calibration weight. So, if you're not sure what the correct weight is, then try a reasonable amount, and verify via the display. You'll see the correct weight during the process.

Linearity

Remove the cover of the instrument. The circuit board at the front has only one adjustment potentiometer, and that is the linearity adjustment. Adjust the pot so that the sensitivity from zero to half scale matches the sensitivity from half to full scale.

1601 -- Calibration / Sartorius

1.
Empty pan, TARE, wait for stability indicator "g".
2.
Gently rotate CALIBRATION KNOB (right side) to CAL position.
3.
The instrument will make an audible BEEP sound when calibrated, and indicate one of these displays:

100.0000
150.0000
CC
4.
Return CALIBRATION KNOB back to operating position.

If the procedure doesn't work, as indicated by CE, then one of several problems exists:

- a. Procedure started without "g".
- b. Procedure started at some number other than 0.0000
- c. Balance was upset (lack of stability) during the procedure.
- d. Instrument has a malfunction.

Problems a through c require that the technician be more careful, so that the instrument does not reject the calibration sequence.

2003 -- Calibration / Sartorius

- 1) Level the instrument, warm up 15 minutes minimum.
- 2) Locate red push-button inside hole on right rear side of instrument.
- 3) A 15 gram calibration weight will be required.
- 4) Press TARE to return display to 0.0000 gr.
- 5) Initiate calibration sequence by depressing red button, it should stick in the depressed position. The instrument display will read between -.5000 and -.9000.
- 6) When reading at step 5 is stable, push TARE.
- 7) Instrument will again read 0.0000. Place 15 gr. calibration weight on pan, (instrument will read between 25 and 30 grams), when display stabilizes, push TARE. Display should now read 15.0000.
- 8) Press red push-button as in step 3, but button will now release to the non-depressed position.

Note: If at any step a button is inadvertently pushed twice, the calibration sequence is invalidated and must be started again. Release red button to the non-depressed position, turn off power for 1 minute, then start again.

2003 and 2004 -- Locking for Transportation and Unlocking for Use / Sartorius

The Sartorius 2000 series balances are often damaged during shipping, when being locked to prepare for transportation, or when being released from the locked condition. The reason is that they are not properly locked and prepared for shipping, or are not properly packaged, or are not set-up correctly. *The following precautions and instructions will prevent mistakes from causing massive damage to these sensitive instruments.*

Sartorius prints the locking/unlocking instructions on the rear of the yellow top cover, or on the rear wall inside the mechanical compartment. The **key to avoiding damage is to FOLLOW THE INSTRUCTIONS to the letter.** Remove the yellow top cover to see the instructions. **Notice that the instructions are for RELEASING the instrument,** not for locking it. Also note that **if you are locking the instrument for transport, you will have to do two things EXACTLY OPPOSITE the instructions.** They are:

1. Start at the end of the instructions, #4, and go backwards to #1.
2. Reverse the direction of rotation at all steps, i.e. counterclockwise vs. clockwise.

Be advised that turning the thumbscrews in the wrong direction will certainly cause MASSIVE DAMAGE. The reason is that the screws (2 & 4) force the beam to opposite positions. Something has to break if they are both rotated clockwise simultaneously.

Locking the beam for transport

Never move the balance (even across the room) without locking down the beam to protect the delicate flexures from damage. Use the following procedure:

1. Remove the pan.
2. Turn **RED knob #4 counterclockwise** several turns.
3. Slide RED plate #3 forward and tighten **RED knob #2 clockwise** until snug.
4. Replace the RED #1 knobs in the threaded holes on either side of the coil/magnet.

It is now safe to transport by hand or in your vehicle -- **IT IS NOT SAFE TO SHIP IN THIS**

CONDITION!

For shipping the following additional steps must be taken:

a. Be very careful not to bump the "V" shaped flexible bearing while performing the following steps! Cut (4) ½" thick foam rubber strips approximately 1" x 3". Place 2 of these carefully on top of the internal weights. Remove the black plate underneath the weights to place the other 2 strips on the underside. Replace the black plate to hold them in place. The foam strips will keep the weights from flying around loose and crashing into the flexures during shipping..

b. The top cover must be taped or otherwise secured.

c. The bottom glass plate is just laying loose on the bottom of the weighing chamber and must be taped securely in place, or better, just removed and kept until the balance is returned to you.

d. The doors must be taped securely shut, or better, removed and kept.

e. The pan and all loose accessories must be protected in a separate box. Place the instrument inside a large plastic bag to keep debris out.

f. Never ship these instruments without an adequate box. IES makes special boxes available to customers at no cost, call for a good box.

2003 and 2004 -- Locking for Transportation and
Releasing Transport Locking Mechanism

1. Remove the top cover of the balance.
2. Notice the "V" shaped aluminum guide on top of the weighing mechanism. This guide is very fragile and easy to inadvertently bump into or lean a hand or tool on causing it to bend. If it or any of the other very thin flexures in this balance are bent or even stressed, the balance will not perform accurately or consistently.
3. Notice that there are some foam rubber strips surrounding the internal weights to keep them from flying around during shipping. CAREFULLY pull the strips of foam out from on top of the weights. Notice that the bottom "V" shaped guide is near these strips. It is also very vulnerable. The strips of foam underneath the weights can be removed via the access cover on the ceiling of the *weighing chamber*. Replace the access cover and hang the pan in the chamber.
4. On the front of the cell on each side of the coil and magnet are two RED screws labeled "1". Remove both of these and place them just to the right in the *red holes* for storage.
5. Now near the rear of the beam are 2 RED "knobs" and a RED "plate" marked 2, 4, and 3 respectively. Turn **knob #2 counterclockwise** to the top of it's rotation. Then slide the plate ,#3, to the rear. Then **slowly turn knob #4 clockwise** until it is finger tight only.
Knob #2 and knob #4 are NEVER both turned down in the clockwise direction at the same time -- NEVER! Mechanical breakage will surely occur if you do!
6. Now the balance is ready to warm-up. Plug it in, turn it on, and make sure it is level and on a very stable surface. If you don't get zeros and weight displaying now, give us a call at 1-800-541-0852. If it appears to be working -- *let it sit and wait until it has warmed up for at least a day (24hrs.)*

[11/12/98]

2003 -- Packing Instructions / Sartorius

Please see the other articles in this handbook regarding locking and unlocking the 2003.

1. Always use a sturdy box, with enough room for loose fill material all around. Generally, balances should be packed so that they are surrounded by a shock absorbing material, such as springy foam rubber, or Styrofoam loose fill. Loose fill settles considerably.
2. Protect the glass doors by opening them, taping them in place, and putting the entire balance in a plastic bag. In this way, the doors are protected by the metal sides.
3. Follow the Sartorius lock down instructions to the letter, they are printed on a label on the rear panel, underneath the yellow top cover. Pay particular attention to the fact that you have to do the procedure in exact reverse to what is printed, since the instructions are for release from lock down. Also, notice that some screws rotate clockwise, others counterclockwise, to lock down. See the section of this handbook on "Locking the beam for transport."
4. In addition to the printed instructions, I recommend that you further protect the delicate beam assembly by placing a strip of foam rubber (cut to fit) underneath the weights. To do this, remove the door in the ceiling of the weighing chamber, (remove thumbscrew) insert the foam, and replace the door. The door and foam now lift the weights from beneath, rather than having their weight supported on the beam assembly. It is also a good idea to put a strip of foam on top of the weights. This keeps them from falling out during shipping.
5. You may want to secure the pan to the bottom of the weighing chamber with tape. In any case, the pan must be detached.
6. IES makes shipping containers for analytical balances available to customers at no cost. We will ship the container anywhere within the US by UPS ground at no cost. These boxes have been made to our specifications, and are specifically made for analytical balances.

[7/15/98]

SAUTER

Sauter Platform Diagram

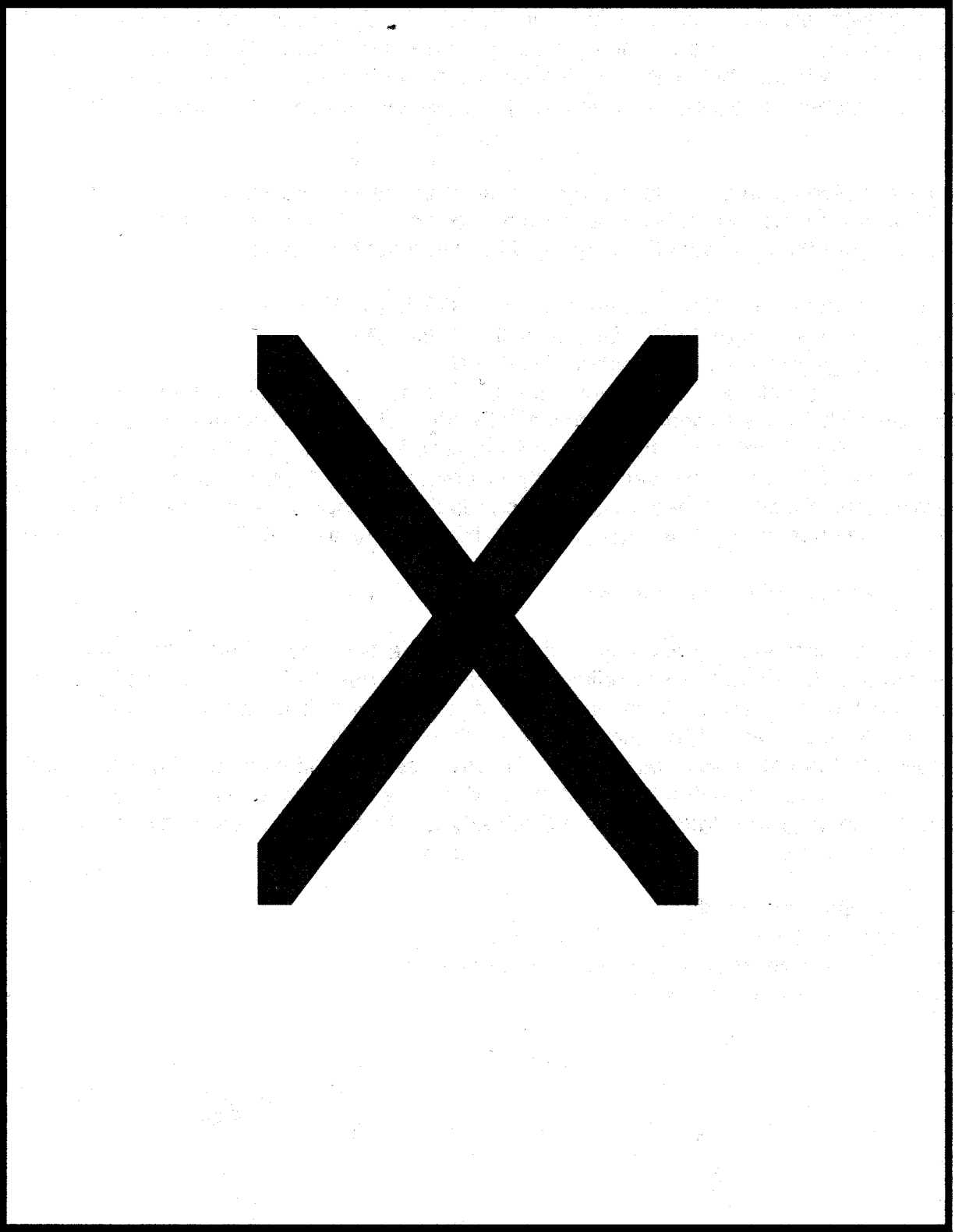

Lock Platform – Sauter

SAUTER PLATFORM

- LOCK DOWN + STOP -

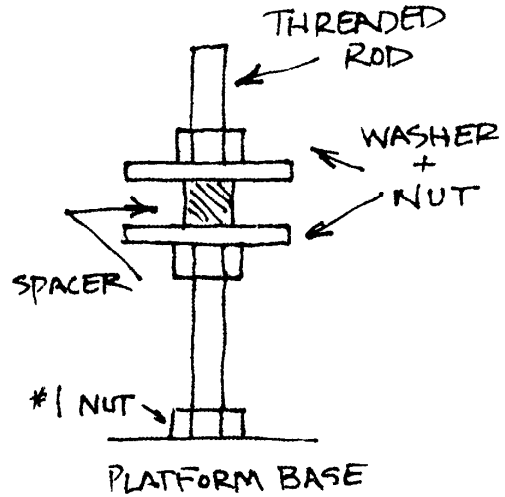
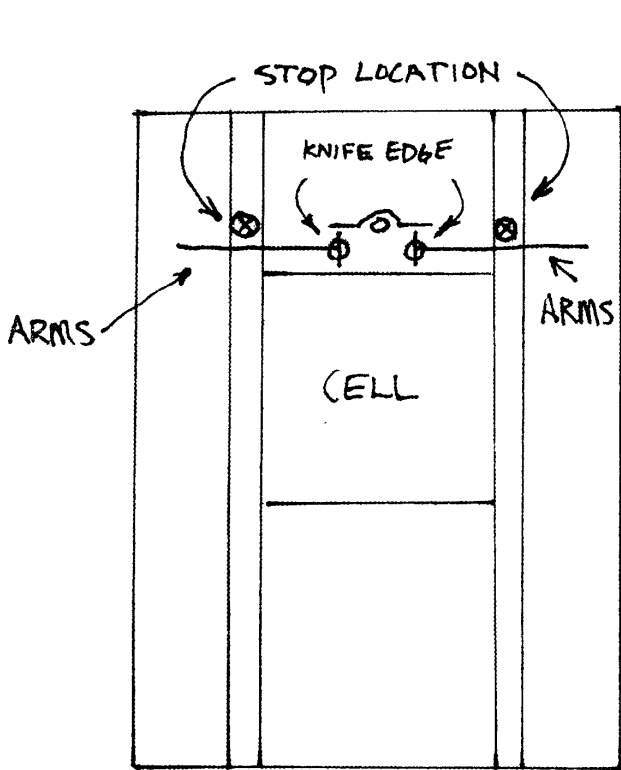

STOP ADJUSTMENT

- 1) LOOSEN #1 NUT
- 2) TURN THREADED ROD TO CENTER STOP PIN BETWEEN WASHERS
- 3) TIGHTEN #1 NUT

PLATFORM ARMS HAVE A STOP PIN THAT SHOULD BE CENTERED BETWEEN STOP WASHERS WHEN KNIFE EDGES RESTS ON DISK ON THE FRONT OF CELL

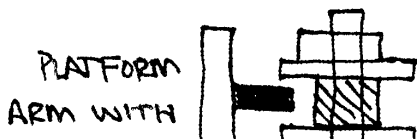



E3380 -- Calibration / Sauter

1) E3380 has an involved overall linearity/calibration procedure. This note covers only calibration.

2) In order to calibrate, the instrument must be in TEST MODE. To set that, it is necessary to remove the front panel of the indicator, thus exposing the circuit board. Once exposed, notice several sets of "spring switches" below the display tube, with two potentiometers within the group. These wire spring switches, in conjunction with the left-most of the two pots, are used to adjust calibration.

3) Unplug the power cord. Switch 24 is the right most of the group. Be sure it is CLOSED. Set potentiometer P1 (left-most of two pots) to a middle position. Set switches 1 through 5 to the OPEN position (these are the left-most 5 switches). The pan must be in place.

- 4)
- a) Plug in and turn ON. Display will indicate HELLO then 000000.
 - b) Depress INFO key, then >0<. Display will indicate A .
 - c) Place cal. weight equal to 1/4 capacity on the pan.
 - d) Press >T< to acknowledge weight has been placed. Indicator should show some number greater than 150000. Use spring switches 1-5 to adjust the displayed number as close as possible to 150000. Switch 1 will make the biggest effect, S5 will make the least. Close S1 first, and leave it closed IF the displayed number is greater than 150000. Sequentially close switches 2-5, leaving only those switches closed which result in a display greater than 150000.

When all 5 switches have been tried, adjust the display to 150000 exactly using P1 potentiometer.

Do NOT remove the weight from the pan.

5) Notice the 8 spring switches immediately to the right of the two pots. These are switches 9 through 16. We will use 12 through 16 to adjust preload. Press >T<, the display shows either an upper or a lower segment lit in each of 5 digit positions. The left-most digit position corresponds to the left-most switch; S12. Similarly, the right-most digit position corresponds to the right most switch; S16. An upper segment lit indicates "switch closed", and visa versa. The display indicates the position to which the 5 switches (12-16) should be moved for proper pre-load. If the switches are not already positioned as indicated by the display, move them to those positions.

- 6)
- a) Remove weights from platform.
 - b) Return spring switch 24 to the OPEN position.
 - c) Press >T<, display shows HELLO, then zeroes.
Unit is now in operating mode.

ED2180 and 2080 Multiscale -- Calibration /**Mettler/Sauter****1) GENERAL INFORMATION**

The instrument uses spring-clip switches on the main board (in the indicator) to set the indicator to match various platforms, and to adjust the operation of the indicator. The spring-clips are either CLOSED (ON position), or OPEN (OFF position).

Clip # Function

- 1 Coarse calibration - Most significant
- 2 Coarse cal
- 3 Coarse cal
- 4 Coarse cal
- 5 Coarse calibration - Least Significant
- 6-8 Not used

Potentiometer #1 Fine calibration adjust
 Potentiometer #2 Test Condition; DO NOT ADJUST

- 9-11 Platform select - see table #1
- 12-16 Preload
- 17-21 Linearity; 17 is most significant, 21 is least significant
- 22-23 Resolution select - see table #2
- 24 Test mode enable; disables underload/overload indicator etc.

2) CALIBRATION INSTRUCTIONS - Platform & Resolution Select

Platform	Capacity	Switches			
model	lbs	9	10	11	0=OPEN 1=CLOSED

EA15	30	0	0	0	
EB60	120	0	0	1	
EC240	480	0	1	0	
ED600	1200	1	0	0	
ED1500	3000	1	0	1	Table #1
EN1500	3000	1	0	1	
EE3000	6000	1	1	0	
EGS6000	12,000	1	1	1	

Approximate	Switches	
Resolution	22	23

6,000	1	1	
15,000	1	0	Table #2
30,000	0	1	
60,000	0	0	

(Continued next page)

ED2180 and 2080 Multiscale -- Calibration (continued p. 2) / Mettler/Sauter**3) LINEARITY CHECKING**

Two test weights, each approximately 1/2 capacity, are required. Disregard the decimal point, so that all readings are recorded as whole numbers. (Example: 36.449 becomes 36449).

- a. Place weight A on the pan, note reading. This is "A"
- b. Remove weight A, replace with B. Tare.
- c. Place A on with B. Note reading. This is "C"
- d. Calculate $A - C = \underline{\hspace{2cm}}$, this is number "D" If D is zero, then go to section 4, otherwise proceed to step e. (Remember to record sign in this calculation.)

LINEARITY ADJUSTMENT

- e. Note settings of switches 17 - 21, write them down.
- f. Using the table #3, calculate the sum of the values of the CLOSED linearity switches. This is "F".

Switch	Value	
17	16	
18	8	
19	4	Table #3
20	2	
21	1	

- g. Calculate $D + F = \underline{\hspace{2cm}}$. This is "G".
- h. Change the switch settings so that new sum of values is equal to G.
- i. Start again from step a. to verify good linearity.

4.) SPAN

- a. Tare instrument to all zeroes, place calibration weight on pan.
- b. Calculate percent error.
- c. Use table #4 to figure out which calibration clip-switches to close or open. Closing switches increases calibration.

Switch	%	
1	8	
2	4	Table #4
3	2	
4	1	
5	.5	

Potentiometer P1 - .3% range

- d. Remove test weight and re-tare. Repeat a. through c. as necessary.

(Continued next page)

ED2180 and 2080 Multiscale -- Calibration (continued p. 3) / Mettler/Sauter

5) E2180 PRELOAD (Deadload) ADJUSTMENT

1. If the instrument indicates overload or underload (all top segments , or all bottom segments, of the numeric display) , then preload adjustment is required. This may be the case after any measuring cell or electronic repair. Damaged cells or defective electronic circuits will not be "repaired" by preload adjustment.
2. Turn power OFF
3. Remove top cover of indicator, but leave connector plugged in.
4. Close switch #24. Make sure the pan is in place on the platform.
5. Turn power ON and wait for zeroes *after* HELLO on the display.
6. Press the INFO button, then >0< while INFO shows on the display. Display shows A .
7. Press >T< . Display shows a number. Press >T< again. The display shows either:

A - a display like this



or

B - a sequence of dashes, upper or lower.

A: Correction of deadload error is not possible, because of cell damage or electronic failure in the indicator or Mechanical Deadload is required.

B: a total of 5 dashes, corresponding to the correct setting of spring switches 12 through 16. An upper dash indicates a closed switch, lower indicates open.

example:

—	—	—	—	—
12	13	14	15	16
closed	closed	open	closed	open

8. Record on paper the switch positions indicated on the display. Power OFF, then place the switches in those positions. If instrument still indicates underload or overload, then circuit or electronic failure exists.

1200 and 1300 Series -- Calibration / Sauter

INTRODUCTION

These instruments are calibrated from the front panel of the readout unit; there are no potentiometers for either calibration/span or linearity. The front panel buttons are used to input codes etc.

The marking of the buttons on the readout is such that they cannot be duplicated in text, therefore this tech note will use the following symbols IN PLACE OF the actual button marking:

Button	Symbol in this tech note
C with arrow button	C>
T with double arrow	>T<
Double curved arrows	>O<
Upside-down delta	UD

Many instrument functions are programmable from the front panel. You can skip those programming steps by pressing >T< to confirm the existing setting, and move on to the next step.

0) If you intend to adjust linearity under software control, you'll need the linearity code. It is a 5 digit sequence of 1's and 0's. This may be written on a paper inside a plastic pouch, which is attached to the platform's cable. It may be written inside the platform on the cell or on the underside of the pan.

1)

Unplug power. Unplug platform from indicator. Plug in power, and turn ON the indicator. Turn OFF the indicator.

2)

a Re-connect platform to indicator. Turn ON indicator. A 5 digit number will show on the readout. Push >T< .

b Confirm CONFIGURATION mode by pressing >T< again.

c Confirm FUNCTION mode by pressing >T< again. (Note: If you want to be able to switch between lbs. & kg. you must select "hb44" mode here.)

d Confirm the existing CAPACITY setting by pressing >T< again

e Confirm the existing INTEGRATION TIME by pressing >T< again

(Continued next page)

1200 and 1300 Series -- Calibration (continued) / Sauter

3) LINEARITY procedure

To keep the old linearity code, press >T<. Now go to step 4.

To change the linearity code, do the following:

c Now, the 5 digit linearity factor will be loaded. Start with the left-most digit of the linearity code. You will press either the >C or the >O< button once for each of the 5 digits. The >C button represents 1. The >O< button represents 0. Each time you press a button, another 1 or a 0 will appear on the display.

If you make a mistake, just start again with the left-most digit. The erroneous digits you have entered will disappear, because only 5 digits can show.

When those 5 digits are correct, confirm with >T< .

4) This step will be encountered only if the instrument is operating as a HB-44 instrument. That function would have been programmed in previously. If you see ZERO on the display, proceed now to step 5. If the display is showing a unit of measure (kg, lb, etc.), select the desired unit of measure pressing the C< button. Each time you depress the C< the units will change. Confirm your selection with >T<.

5) a The display will now be showing ZERO . Verify that there is no weight on the platform, and press >T< to confirm.

b Load a test weight of at least 1/4 of capacity onto the platform. By pressing either the C< or the >O< key, the displayed weight will count upward or downward.

Upward counting - C< Downward counting - >O< UD button (Quickens count-- must hold down with C< or >O<.)

Stop when the displayed number matches the test weight. Confirm accurate reading with >T<. Do NOT remove test weights yet. The displayed number may have changed; that's OK for now.

c Again adjust the displayed number so that it matches the test weight, and confirm with >T< .

d System is now calibrated.

6) Verify that the instrument is linear. If not, experiment with new linearity codes at step 3 above. The left-most digit of the linearity code is the least significant, and therefore makes the least change to linearity. Write the correct linearity code on the tag or the underside of the pan.

SHIMADZU

AEU-210 -- Calibration Weight Mounting / Shimadzu

This article concerns the mounting of the calibration weight in the AEU instrument. This weight is likely to be dislodged during shipping.

When the instrument has the calibration weight mounted properly, the digital display will proceed to CAL after showing all 8s when powered up. If the weight is mispositioned, then the unit will remain with all digits showing 8s at power up.

To reposition the calibration weight:

- 1 Remove pan and sub pan.
- 2 Remove drip pan (2 screws).
- 3 Remove stainless steel bottom plate.
- 4 Remove two Phillips screws on bottom of chamber, one left, one right.
- 5 Lift top chassis up and away. Tilt the unit onto its back, being careful of the sliding glass doors.
- 6 Remove two screws, one right and one left, which secure the cell's metal shield.
- 7 Check the weights at the front of the cell. Realign if necessary.
- 8 Be careful of the cables at the rear when reassembling.

BL Calibration – Shimadzu

This instrument uses a menu structure to set internal configuration parameters. That menu is accessed using the TARE key to go to a lower menu level, or the POWRE/BRK key to rise in the menu structure. The highest level in the menu structure is standard weighing mode. Continuously pressing POWER/BRK causes the instrument to return to standard weighing. In the following example of Shimadzu BL-2200 calibration, a 2000 gram weight is called for. Other models in the BL series will requires different weights.

Action	Result
1. warm up 30min, level, tare to zeros	readout shows 0.00
2. Press CAL/MENU	readout shows CAL
3. Press TARE	readout shows required weight , blinking 2000.00
4. wait for stability arrow	→ 2000.00
5. Place the indicated weight value on the pan	2000.00
6. Wait for stabilization	→ 2000.00
7. Press TARE	0.00 blinking
8. Wait for stability	→ 0.00
9. Remove weight from pan Wait for stability Press TARE	0.00 CAL End or CAL E 4 shows on readout .
10. Instrument returns to weighing mode automatically.	

UW Calibration – Shimadzu

UW series instruments have internal calibration weight.

Action	Result
1. warm up 30min, level, tare to zeros	readout shows 0.00
2. Press CAL	readout shows i CAL
3. Press O/T	readout progresses automatically ; i CAL 3 i CAL 2 I CAL 1 Set CALEnd 0.00 g

Calibration is complete

UX Calibration – Shimadzu

UX series instruments do not have internal calibration weights

Action	Result
1. warm up 30min, level, tare to zeros	readout shows 0.00
2. Press CAL	readout shows E CAL
3. Press O/T	readout blinks value of required weight
4. Apply indicated weight Press O/T	blinking zeros
5. Remove weights Press O/T	readout shows Set instrument returns to weighing mode
6. Calibration is complete	

TOLEDO

ID SERVICE MODE / Toledo

Although these instructions are written for the ID5 the other ID's are the same except for the displayed message.

FAQ: See Scale Parameters to change units. See External Calibration for internal cal overwrite.

Enter into SERVICE MODE

- Switch off terminal
- Unplug weighing platform
- Switch on terminal. PLUG IN appears in the display
- Press key →0← until SERVICE MODE appears in the display
- Switch off terminal
- Attach weighing platform
- Switch on the terminal. SERVICE MODE appears briefly in the display followed by the first program block (RETURN).

Overview of program block structure

- RETURN return allows service mode to quit without any changes
- RESET reset clears scale number, cell configuration reset to factory setting
- NATION nation - country is selected
- SCALE PARAMETERS weighing platform, type, maximum capacity, graduations, units
- LINEARITY weighing platform can be assigned a new linearity code
- CALIBRATION internal calibration or external calibration, internal overwrite
- SAVE PARAMETERS the selected configuration is stored

Step through the program blocks by pressing the NO button (→T←)

Enter a program block by press the YES button (←→)

Key Functions: Yes = ←→ No = →T←

RETURN BLOCK

Press YES to return to weighing mode- normal operation

Press NO to enter service mode

RESET BLOCK

Press YES to reset weighing platform, certification capability, maximum capacity, range and graduation to factory settings. Display shows NO RESET press NO, display shows RESET ALL press YES. Display shows POWER OFF, Switch off the power then on again, the scale will calibrate internally.

NATION

United States of America = USA

SCALE PARAMETERS

Press YES to enter, and select with YES & NO keys

- W+M approval noncertified = NO W+M approval certified = W+M approval
- KA15 NO key steps through platforms, YES when desired platform is displayed
- CAP maximum capacity of the weighing platform is displayed, set maximum operating capacity (also can be selected in pounds "lbs" - **the unit the capacity is set for will be the unit displayed in the normal operating mode**)
- MR MR represents multirange, (Press Yes/No for resolution setting of multirange)
- D D represents single range. (Press Yes/No for resolution setting of single range)

ID SERVICE MODE / Toledo--Linearity

Press YES to view linearity code, Press YES to keep current code or press NO to enter a new code. The instructions below will show 3 columns. Left most is the **Display** column, which shows the indicator's digital display at each step. In the center is the technicians **Response** (via the keys) to that display. The right-most column briefly describes the **Function**, or purpose, achieved at that step.

Functions: Yes =C→ No = →T←

Special Note: At several steps yet to come, the display will show a linearity code number (code#). Since the display can't make a + sign, the -I is used instead. Of course, it can make the - sign. You'll need to read the sign from the digital display at step 2f, and enter a sign at step 2g. In this service memo. We'll use the ♣ symbol to represent a digit where a sign symbol will be.

	Display	Response	Function
f.	L ♣ # # # #	No	don't use existing code ♣ # # # #, write this number on the chart, shown below
g.	At this point, you've got to pick a 4 digit code number (code#). Larger numbers will make the mid-span readings lower, smaller (or more negative) numbers make them higher. Based on the error at midspan (from step 1) and the number indicated at step 2f, decide whether you need to go + or - from the current number.		
h.	L _ _ _ _ ♣	repeated No Yes	cycle between + and - signs confirm sign
i.	L _ _ _ - ♣ 0	repeated No Yes	enter most significant digit of code# confirm digit
j.	L _ _ - ♣ # 0	repeated No Yes	enter next digit of code# confirm digit
k.	L _ - ♣ # # 0	repeated No Yes	enter next digit of code# confirm
l.	L - ♣ # # # 0	repeated No Yes	enter least significant digit of code# confirm
m.	L - ♣ # # # #	Yes	accept entered whole code #

LINEARITY DONE

As illustrated in the chart below, the successive iterations of code#, and resultant linearity performance can be recorded. This makes it easier (and quicker) to make good estimates for the code #.

Linearity Chart

	<i>Code #</i>	<i>1/2 Scale Error</i>	
<i>AS FOUND</i>	<i>+0538</i>	<i>+8</i>	
<i>1</i>	<i>+1500</i>	<i>-11</i>	<i>(went too far.)</i>
<i>2</i>	<i>+1000</i>	<i>-1</i>	<i>(that's better)</i>
<i>3</i>	<i>+0.950</i>	<i>0</i>	<i>done</i>

ID SERVICE MODE / Toledo--Calibration

(calibrating Externally will automatically rewrite the internal calibration weight)

Press YES to Calibrate

<u>Display shows</u>	<u>Action</u>
Set Preload	Unload scale , press YES
Calibration	Scale prepares for calibration
Cal Ext	Scale can be calibrated externally with YES, or NO to go to Internal Calibration

External Calibration

Fullcap Place full capacity on scale and press YES

If you do not have full capacity follow these instructions.

You will enter a 5-digit number, representing your calibration weight.

“No” key cycles the number, then “Yes” to confirm.

(for our example we will calibrate with 100lb.)

- 1. YesFULLCAP
- 2. NoC # # # # lb
- 3. NoC _ _ _ 0 lb
- 4. YesC _ _ _ 0 0 lb
- 5. YesC _ _ 0 0 0 lb
- 6. NoC _ _ 0 0 1 lb
- 7. YesC _ 0 0 1 0 lb
- 8. YesC 0 0 1 0 0 lb
- 9. Load the weight on pan and press YESCal, then UNLOAD
- 10. YesCal, then SAVE
- 11. YesScale resets and returns to weigh mode

CALIBRATION DONE

Unload Unload Weighing platform. Done

Internal Calibration

Cal Int YES will calibrate and exit Calibration Block ←

SAVE PARAMETERS

Press YES to store configuration

RETURN

Press YES to return to weighing mode.

ID1 -- Changing Unit 2 of Measure / Toledo

1. Enter Mastermode by pressing and holding the $\leftarrow \rightarrow$ key until "Master" appears on the display.
2. Press $\leftarrow \rightarrow$, display shows F Key
3. Press $\leftarrow \rightarrow$, display shows Gross
4. Press $\rightarrow T \leftarrow$ key until display shows UNIT
5. Press $\leftarrow \rightarrow$
6. Press $\rightarrow T \leftarrow$ until desired unit of measure is displayed.
7. Press $\leftarrow \rightarrow$
8. Display shows END
9. Press $\leftarrow \rightarrow$

ID 5 – Changing or Selecting Unit 2 / Toledo

Enter Master Mode.

Press following Keys:

- Mode
- ABC ...
- CD
- Shift
- KL
- EF
- AB
- Shift
- QR
- Enter

Display shows “ Load Fix-Tare E?.”

Press Shift Key until display shows “Second Unit ?.”

Press Enter Key.

Press Shift Key to cycle through Unit options.

Press Enter when you see desired unit.

Display shows “ END. “

Press Enter Key. Scale will revert to weighing mode.

The U w/ circular arrows on top of the keypad changes units

ID-SX Service Mode Notes

When you try to enter Service Mode per our normal ID instructions the indicator simply shows all 8's- you can't go any further.

There is a button inside the indicator (seen on an ID2-SX) on the main board below the keypad.

To enter "Service Mode":

Platform and indicator remain connected.

Press and hold the "zero" key, then press the button inside the indicator.

"Service Mode" is briefly displayed.

Proceed with our normal instructions in handbook.

(an ID2 was missing "Scale Parameters" in the program blocks after Service Mode was entered. "Reset" was selected and then scale turned off and re-entered Service Mode. Scale Parameters were then available.